

Truck, Trailer & Tail-Light

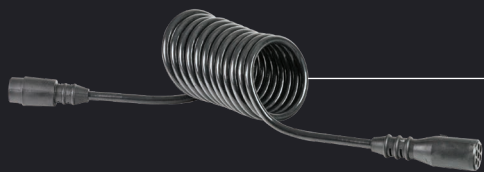

Truck, Trailer & Tail-Light



Suzi Coils **96**



Trailer Connectors **98**



Tail-Light Harnesses **104**

Truck, Trailer & Tail-Light

Suzi Coils



Made in Europe

- Superior resistance to abrasion, ozone, grease, oils and chemicals.
- Plugs are injection-moulded to the coil for maximum durability, excluding RC007.
- Broad operating temperature.
- All Suzi Coils with moulded plugs are 100% electronically tested.
- Made in Europe.

Operating Temperature : -40°C to 85°C

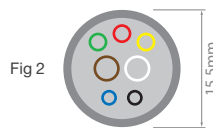
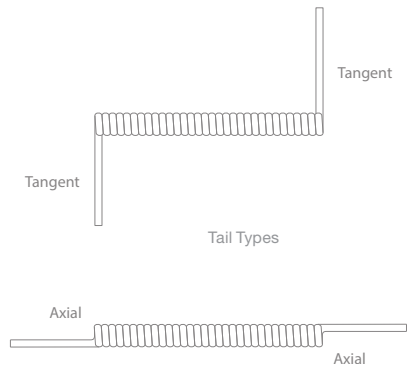

Suzi Coils – With Moulded Plugs – Hytrel Sheathing

Part No.	No. of Cores	Cores x mm ²	Plugs	Working Length (m)	Closed Coil Ø (mm)	Tail Type	Tail Lengths (mm)	Fig
RC009	7	7 x 2.5	N12 x 2	3	90	Axial & Tangent	1 x 200, 1 x 1000	1
RC011	7	7 x 2.5	N12 x 2	3	90	2 x Axial	2 x 200	1
RC023	7	7 x 2.5	N24 x 2	3	105	2 x Axial	2 x 200	1
RC024	7	7 x 2.5	N24 x 2	3	100	Axial & Tangent	1 x 200, 1 x 1000	1
RC025	7	7 x 2.5	N12 & N24	3	95	2 x Axial	2 x 200	1
RC003	7	2 x 6, 3 x 2.5, 2 x 1.5	N12 x 2	4	100	2 x Axial	2 x 200	2
RC006	7	2 x 6, 3 x 2.5, 2 x 1.5	N12 x 2	4	100	Axial & Tangent	1 x 200, 1 x 1000	2
RC030	7	1 x 6, 6 x 2.5	N24 x 2	4.5	110	2 x Axial	2 x 200	3
RC033*	7	1 x 6, 6 x 2.5	N12 & N24	3	90	Axial & Tangent	1 x 230, 1 x 230	3

Hytrel is a Dupont™ high performance engineering rubber.

* RC033 is a Volvo special.

Truck, Trailer & Tail-Light



Fig 1



Fig 2



Fig 3



Fig 4



RC032



Fig 5



Fig 6



Fig 7

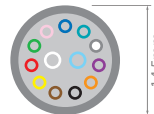

Fig 8



Fig 9

Suzi Coils – Without Plugs

Part No.	No. of Cores	Cores x mm ²	Working Length (m)	Closed Coil Ø (mm)	Tail Type	Tail Lengths (mm)	Sheathing	Fig
RC008	2	2 x 1	1.8	25	2 x Tangent	2 x 200	Polyurethane	1
RC037	2	2 x 1	6	25	2 x Tangent	2 x 200	Polyurethane	1
RC027	2	2 x 1.5	3	28	2 x Tangent	2 x 200	Polyurethane	2
RC028	2	2 x 2.5	3	25	2 x Tangent	2 x 200	Autoprene	3
RC013	7	7 x 0.5	3	20	2 x Tangent	2 x 200	Polyurethane	4
RC014	7	7 x 0.5	2	20	2 x Tangent	2 x 200	Polyurethane	4
RC026	7	7 x 0.75	3.6	28	2 x Tangent	2 x 200	Polyurethane	5
RC031	7	7 x 1.5	8	25	2 x Tangent	2 x 200	Polyurethane	6
RC032	7	1 x 2, 6 x 1	3	28	2 x Tangent	2 x 200	Polyurethane	7
RC001	13	2 x 2, 11 x 1	3	55	2 x Tangent	2 x 200	Polyurethane	8
RC010	7	7 x 2.5	8	100	2 x Axial	2 x 200	Hytrel	9
RC012	7	7 x 2.5	3	90	2 x Axial	2 x 200	Hytrel	9

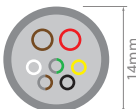

RC007



RC022



RC033



ABS/EBS Plug



N12 Plug



RC022

Suzi Coils – Specialist

Part No.	No. of Cores	Cores x mm ²	Plugs	Working Length (m)	Closed Coil Ø (mm)	Tail Lengths (mm)	Tail Lengths (mm)	Sheathing
RC007 *	7	2 x 4, 5 x 1.5	ABS/EBS x 2	4.5	110	2 x Axial	2 x 200	Hytrel
RC022	7	7 x 0.75	N12 x 1	7.2	29	Tangent & Tangent	2 x 200	Polyurethane
RC033	7	1 x 6, 6 x 2.5	N12 & N24	3	90	Axial & Tangent	1 x 230, 1 x 230	Hytrel

* RC007 is 12V only.



Truck, Trailer & Tail-Light

Trailer Connectors



- Ranges to suit cars & trucks.
- Specialised ABS/EBS connectors available.
- 16-720 & 16-730 feature weather-proof seal.

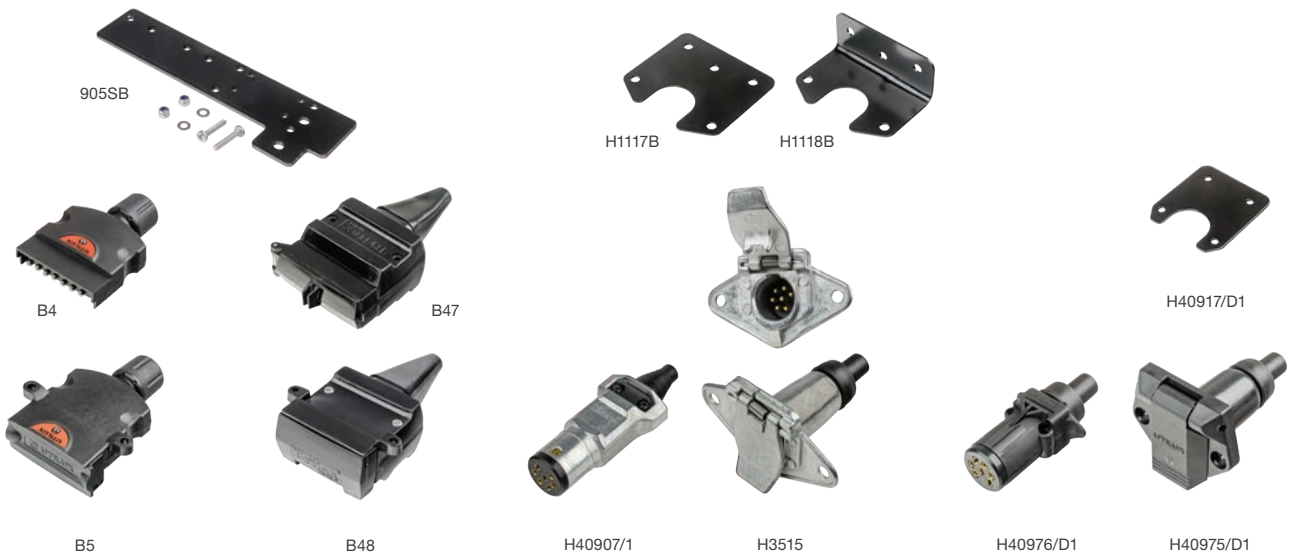

Trailer Connectors – Car

Part No.	Voltage	Type	Total Circuits	Material	Brackets to Suit
B4	12–24	Plug	7	Plastic	—
B5	12–24	Receptacle	7	Plastic	905SB
B47	12–24	Plug	12	Plastic	—
B48	12–24	Receptacle	12	Plastic	905SB
H40907/1	12–24	Plug	7	Metal	—
H3515	12–24	Receptacle	7	Metal	H1117B, H1118B
H40976/D1	12–24	Plug	7	Plastic	—
H40975/D1	12–24	Receptacle	7	Plastic	H40917/D1

Truck, Trailer & Tail-Light

Made in Europe



3000P/12V
3000P/24V



90° bayonet style
cable outlet



3004P/12V



3005P/24V



3001S/12V
3001S/24V



3002S/12V
3002S/24V



3003S/12V



3005S/24V

Trailer Connectors – ABS/EBS

Part No.	Voltage	Type	Total Circuits	Contact Configuration	Cable Ø (mm)	Cable Outlet		Contacts
3000P/12V	12	Plug	7	2 x 6mm ² & 5 x 1.5mm ²	15–17	Straight	Screw-On	Crimp
3000P/24V	24	Plug	7	2 x 6mm ² & 5 x 1.5mm ²	15–17	Straight	Screw-On	Crimp
3001S/12V	12	Receptacle	7	2 x 6mm ² & 5 x 1.5mm ²	15.5	Straight	Screw-On	Crimp
3001S/24V	24	Receptacle	7	2 x 6mm ² & 5 x 1.5mm ²	15.5	Straight	Screw-On	Crimp
3002S/12V	12	Receptacle	7	2 x 6mm ² & 5 x 1.5mm ²	15.5	90°	Bayonet	Crimp
3002S/24V	24	Receptacle	7	2 x 6mm ² & 5 x 1.5mm ²	15.5	90°	Bayonet	Crimp
3004P/12V	12	Plug	7	1 x 1.5mm ²	15–17	Straight	Screw-On	Screw
3003S/12V	12	Receptacle	7	1 x 1.5mm ²	15.5	Straight	Screw-On	Screw
3005P/24V	24	Plug	15	12 x 1.5mm ² & 3 x 2.5mm ²	11.5–14.5	Straight	Screw-On	Crimp
3005S/24V	24	Receptacle	15	12 x 1.5mm ² & 3 x 2.5mm ²	7–12	Straight	Bayonet	Crimp

ABS/EBS connectors supplied with contacts.



Truck, Trailer & Tail-Light



Made in North America

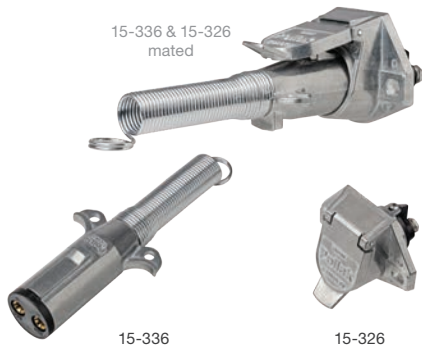

Made in North America

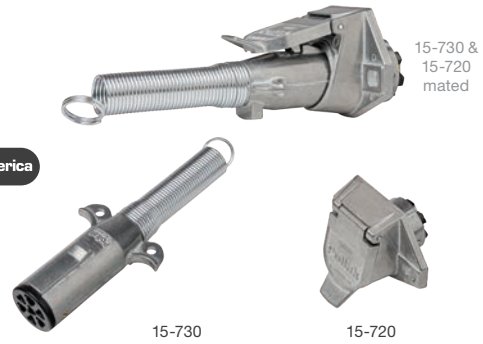

Made in Europe



Trailer Connectors – Truck

Part No.	Voltage	Type	Total Circuits	Material	Description
16-730	12-24	Plug	7	Plastic	
16-720	12-24	Receptacle	7	Plastic	
N1200	12-24	Plug	13	Plastic	
15-336	12-24	Plug	2	Metal	200A
15-326	12-24	Receptacle	2	Metal	200A
15-730	24	Plug	7	Metal	
15-720	24	Receptacle	7	Metal	
N24P	24	Plug	7	Metal	
N24S	24	Receptacle	7	Metal	
N12P	12	Plug	7	Metal	
N12S	12	Receptacle	7	Metal	
N12S-GKT	Gasket to suit N12S				

Truck, Trailer & Tail-Light



Trailer Connectors – Military

Part No.	Voltage	Type	Total Circuits	Description	Outlet
6.00877.001	12–24	Receptacle	12	Metal Cover, Panel Mount Flange, Plastic Conduit Adaptor	NW17
6.00877.000	12–24	Receptacle	12	Metal Cover, Panel Mount Flange	NW17
6.00943.000		Metal Cover			
6.00879.000	24	Plug	12	ISO 11446	



Truck, Trailer & Tail-Light Connectors





Truck, Trailer & Tail-Light

Tail-Light Harnesses



CKH-H001

- Plugs directly into existing harness.
- Suits a range of chassis including Toyota Hi-Lux, Land Cruiser, Ford Ranger and Mazda BT50.
- Sealed connectors.
- For ease of modification to O.E. rear lamp harness.

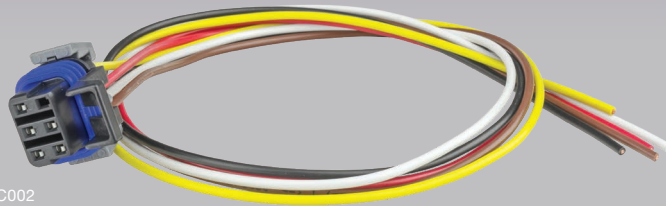

CKH-C002



CKH-R001



CKH-R002



CK-001

Tail-Light Harness – Ford/Mazda

Part No.	Suits	Description	Kit Contents
CKH-R001	Ranger (cab/chassis)/BT50	Plug to Plug	
CKH-R002	Ranger (cab/chassis)/BT50	Plug to Tail	
CK-001	Ranger (cab/chassis)/BT50	Connector Kit	1 x Connector Housing, 6 x Seals, 6 x Contacts

600mm extension length.

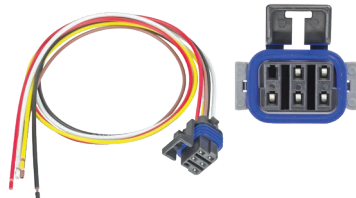

CKH-C002



CK-007

Tail-Light Harness – GM/Chevrolet

Part No.	Suits	Description	Kit Contents
CKH-C002	Colorado	Plug to Tail	
CK-007	Colorado	Connector Kit	1 x Connector Housing, 6 x Seals, 6 x Contacts

600mm extension length.

Truck, Trailer & Tail-Light

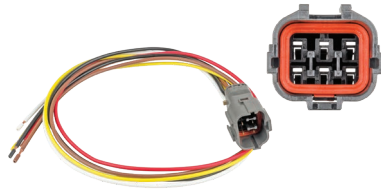

CKH-D002



CK-002

Tail-Light Harness – Isuzu

Part No.	Suits	Description	Kit Contents
CKH-D002	D-Max	Plug to Tail	
CK-002	D-Max	Connector Kit	1 x Connector Housing, 1 x Retainer, 6 x Seals, 6 x Contacts

600mm extension length.



CKH-M002



CKH-M003

Tail-Light Harness – Mitsubishi

Part No.	Suits	Description
CKH-M002	Triton MN	Plug to Tail
CKH-M003	Triton MQ	Plug to Tail

600mm extension length.

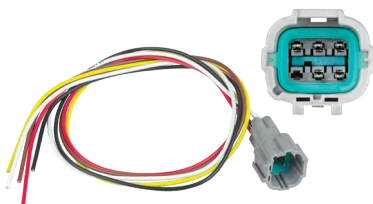

CKH-N002



CKH-N003

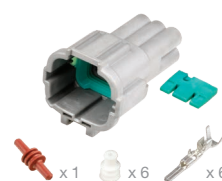

CK-004



CK-005

Tail-Light Harness – Nissan

Part No.	Suits	Description	Kit Contents
CKH-N002	Navara D40	Plug to Tail	
CKH-N003	NP300	Plug to Tail	
CK-004	Navara D40	Connector Kit	1 x Connector Housing, 1 x Retainer, 1 x Cavity Plug, 6 x Seals, 6 x Contacts
CK-005	NP300	Connector Kit	1 x Connector Housing, 1 x Retainer, 8 x Seals, 8 x Contacts

600mm extension length.



Truck, Trailer & Tail-Light

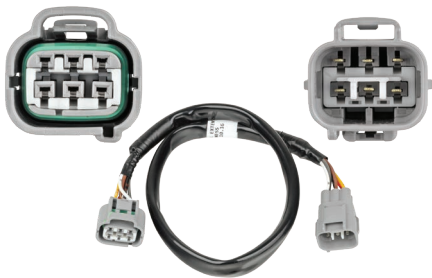

CKH-H001



CKH-H002



CK-006

Tail-Light Harness – Toyota

Part No.	Suits	Description	Kit Contents
CKH-H001	Hi-Lux & Land Cruiser	Plug to Plug	
CKH-H002	Hi-Lux & Land Cruiser	Plug to Tail	
CK-006	Hi-Lux & Land Cruiser	Connector Kit	1 x Connector Housing, 6 x Seals, 6 x Contacts

600mm extension length.



Truck, Trailer & Tail-Light

Choose one of the auxiliary wires to connect to the indicator on the opposite side of the vehicle, the other can be used for beacons, work lamps etc.



CKH-H101



CKH-R101

Tail-Light Adaptor Harnesses

Part No.	Suits
CKH-H101	Land Cruiser & Toyota Hi-Lux
CKH-R101	Ford Ranger (cab/chassis)

400mm extension length.

TE DEUTSCH Connector Pin Layout 2016 on Land Cruiser 70 Series

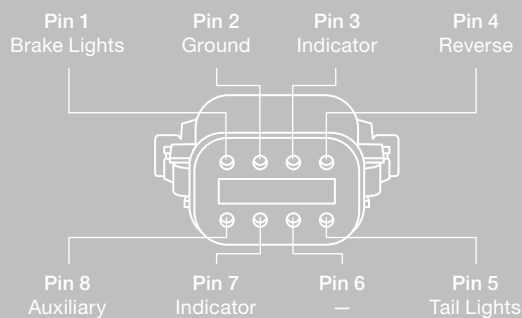

TE DEUTSCH Connector Pin Layout 2016 on Toyota Hi-Lux & Ford Ranger

