



Light Output – Theoretical vs Operating

With their luminous efficiency continuing to increase, LEDs have rapidly become the 'MUST HAVE' light source for work lamps of all sizes and utility.

The newer the technology the greater the frequency of confusing and misleading information in the market. This is especially true with LED technology. The most confused of these is the lumen output figures quoted by many manufacturers.



The light output claims made by LED worklamp manufacturers and suppliers should be questioned in detail because often they quote a mathematically calculated lumen figure based upon trigger pulse measurements provided by LED component makers, and have no relationship to a completed product's actual light output, but is a purely theoretical lumen rating that cannot be achieved in real world conditions.



The real light output depends upon many factors including how effective the lamp body is at dissipating heat, plus the quality and the efficiency of the electronics and lens.

To ensure our customers can make a fair and informed decision, Nordic Lights are now presenting both Theoretical and a 'stabilised' Operating Lumen Output value for the entire LED Worklamp range.

e.g. **Theoretical Lumen Output :** 1500lm
Operating Lumen Output : 1000lm

Theoretical is mathematically calculated as explained above. Operating Lumen Output is measured once the work lamp has run for a period of time reaching a stable thermal level and represents a real world lumen output for a lamp used in normal conditions.

High Quality

Designed and manufactured using the same European engineering, attention to detail and high quality components as the Heavy Duty series, the Nordic Lights General Purpose range of LED worklamps offer a cost-effective alternative for general applications, such as service vehicles, 4WD's, trucks or forklifts.



Nordic General Purpose LED

KL1901 LED	38
CANIS GO 410 LED	40
KL2001 LED	42
SCORPIUS GO 420 LED	44
KL1401 LED	46

Nordic General Purpose LED

NEW

KL1901 LED



- Cost effective, high quality worklamp.
- Compact design.
- Multi-voltage.
- Long life LEDs.
- Low current draw.
- Over voltage, over temperature, spike & polarity protected.
- Environmentally sealed cast alloy body.
- Extreme shock resistance.
- Even light pattern without hotspots.
- Deutsch DT connector encapsulated in body.
- 5 year warranty.

Theoretical Lumen Output :	1500lm
Operating Lumen Output :	1000lm
Operational Voltage :	9-32V
Input Current :	0.7A @ 24V
Max Power Consumption :	19 Watts
LED Lifetime :	50,000 Hrs
Connector :	Deutsch DT Series 2 Pin
Mount :	Single Bolt M8
Shock :	60G
Vibration :	8G rms 24 - 2000Hz
Lens :	Grilamid®
Body :	Aluminium
Weight :	0.5kg
Ingress Protection :	IP68, IP6K9K
Salt Mist :	ISO 9227 240H
EMC :	ISO 13766, ISO 14982, ISO 7637-2, EN12895
Operating Temperature :	-40°C to 85°C
Colour Temperature :	5700K
Light Source :	6 x Nichia® NCSWE17AT

- 9V
32V
- IP68
- IP
6K9K
- 5Yrs

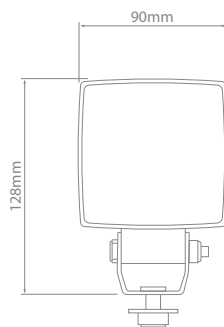
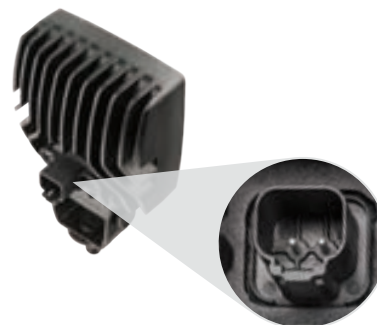

Nordic General Purpose LED

KL1901 LED – Flood

Part No.
988-408

Operational Voltage
9-32

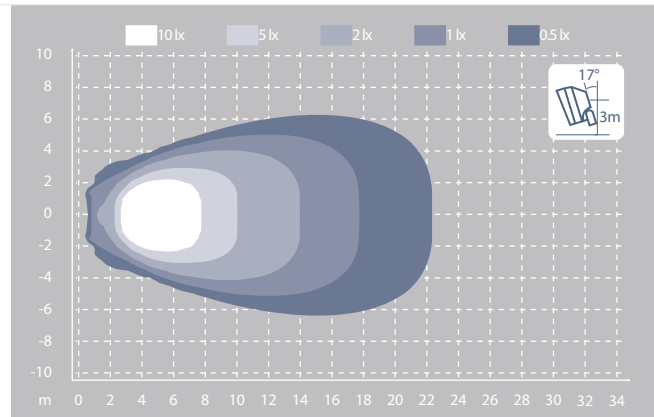

Nordic General Purpose LED

NEW

CANIS GO 410 LED



- Cost effective, high quality worklamp.
- Compact design.
- Multi-voltage.
- Long life LEDs.
- Low current draw.
- Over voltage, over temperature, spike & polarity protected.
- Environmentally sealed cast alloy body.
- Extreme shock resistance.
- Even light pattern without hotspots.
- Deutsch DT connector encapsulated in body.
- 5 year warranty.

Theoretical Lumen Output :	1600lm
Operating Lumen Output :	1000lm
Operational Voltage :	9-32V
Input Current :	0.6A @ 24V
Max Power Consumption :	16 Watts
LED Lifetime :	50,000 Hrs
Connector :	Deutsch DT Series 2 Pin
Mount :	Single Bolt M8
Shock :	60G
Vibration :	8G rms 24 - 2000Hz
Lens :	PC
Body :	Aluminium
Weight :	0.5kg
Ingress Protection :	IP68, IP6K9K
Salt Mist :	ISO 9227 240H
EMC :	ISO 13766, ISO 14982, ISO 7637-2, EN12895
Operating Temperature :	-40°C to 85°C
Colour Temperature :	5000K
Light Source :	6 x Nichia® NCSWE17AT

9V 32V IP68 IP 6K9K 5Yr5

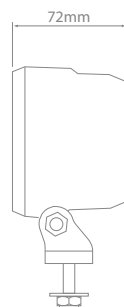
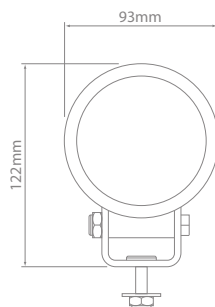

Nordic General Purpose LED

CANIS GO 410 LED – Flood

Part No.
988-102

Operational Voltage
9-32

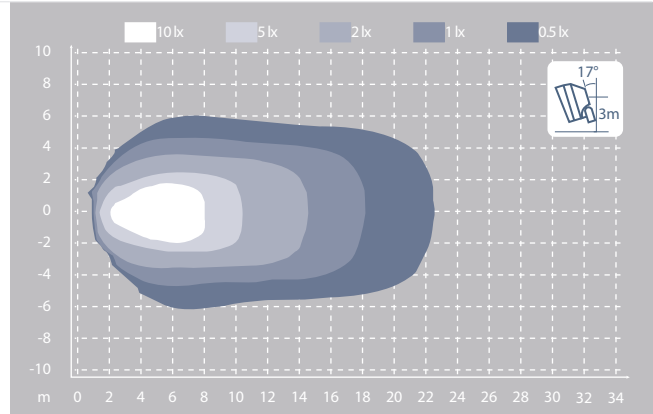

CANIS GO 410 LED – Wide Flood

Part No.
988-101

Operational Voltage
9-32

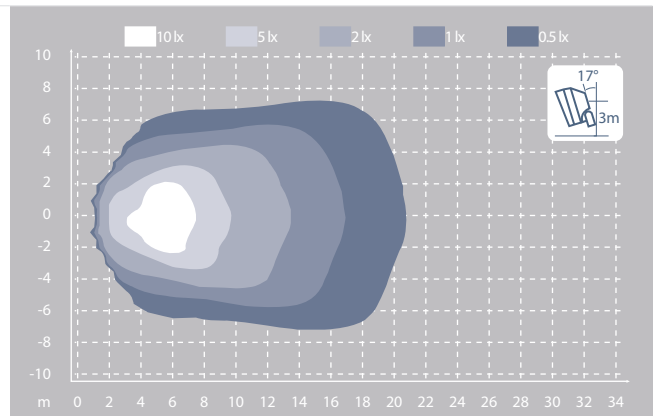

IONNIC Minebars

The Nordic GO 410 LED Worklamp now available as an option on the latest IONNIC Minebars.
For further information ask your local reseller or visit ionnic.com



Nordic General Purpose LED

NEW

KL2001 LED



- Cost effective, high quality worklamp.
- Compact design.
- Multi-voltage.
- Long life LEDs.
- Low current draw.
- Over voltage, over temperature, spike & polarity protected.
- Environmentally sealed cast alloy body.
- Extreme shock resistance.
- Even light pattern without hotspots.
- Deutsch DT connector encapsulated in body.
- 5 year warranty.

Theoretical Lumen Output :	1900lm
Operating Lumen Output :	1200lm
Operational Voltage :	9-32V
Input Current :	0.8A @ 24V
Max Power Consumption :	20 Watts
LED Lifetime :	50,000 Hrs
Connector :	Deutsch DT Series 2 Pin
Mount :	Single Bolt M8
Shock :	60G
Vibration :	8G rms 24 - 2000Hz
Lens :	PC
Body :	Aluminium
Weight :	0.5kg
Ingress Protection :	IP68, IP6K9K
Salt Mist :	ISO 9227 240H
EMC :	ISO 13766, ISO 14982, ISO 7637-2, EN12895
Operating Temperature :	-40°C to 85°C
Colour Temperature :	5700K
Light Source :	6 x Lumileds® Luxeon Z ES

- 9V 32V
- IP68
- IP 6K9K
- 5Yrs

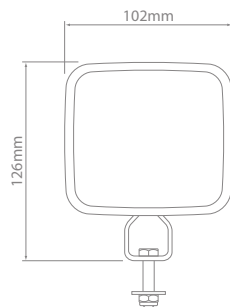

Nordic General Purpose LED

KL2001 LED – Flood

Part No. Operational Voltage
982-609 **9-32**

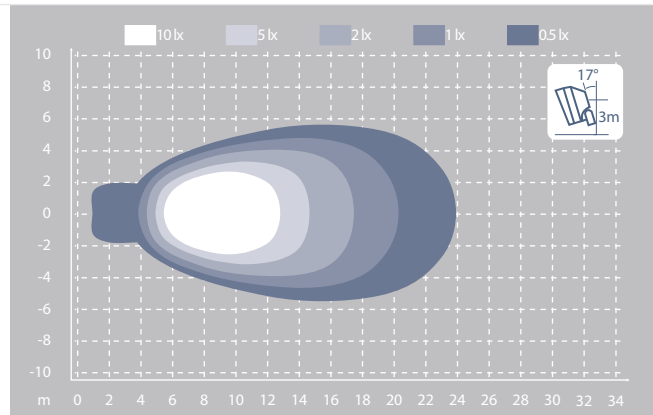

KL2001 LED – Wide Flood

Part No. Operational Voltage
982-608 **9-32**

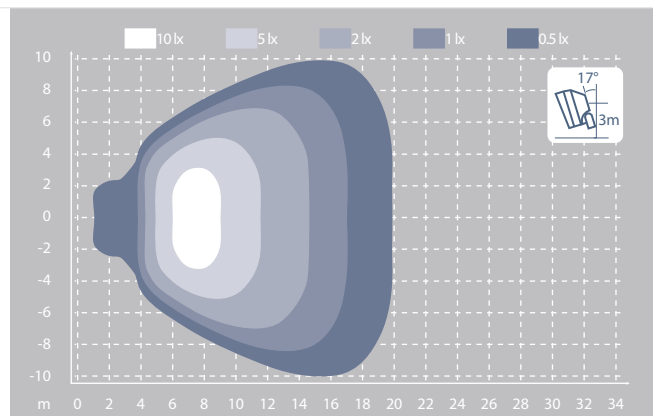

Nordic General Purpose LED

SCORPIUS GO 420 LED

NEW



- Cost effective, high quality worklamp.
- Compact design.
- Multi-voltage.
- Long life LEDs.
- Low current draw.
- Over voltage, over temperature, spike & polarity protected.
- Environmentally sealed cast alloy body.
- Extreme shock resistance.
- Even light pattern without hotspots.
- Deutsch DT connector encapsulated in body.
- 5 year warranty.

Theoretical Lumen Output :	2800lm
Operating Lumen Output :	1800lm
Operational Voltage :	9-32V
Input Current :	1A @ 24V
Max Power Consumption :	28 Watts
LED Lifetime :	50,000 Hrs
Connector :	Deutsch DT Series 2 Pin
Mount :	Single Bolt M8
Shock :	60G
Vibration :	8G rms 24 - 2000Hz
Lens :	PC
Body :	Aluminium
Weight :	0.6kg
Ingress Protection :	IP68, IP6K9K
Salt Mist :	ISO 9227 240H
EMC :	ISO 13766, ISO 14982, ISO 7637-2, EN12895
Operating Temperature :	-40°C to 85°C
Colour Temperature :	5000K
Light Source :	6 x Nichia® NVSWE21AT

- 9V
32V
- IP68
- IP
6K9K
- 5Yrs

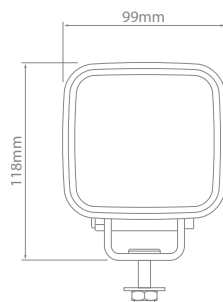

Nordic General Purpose LED

SCORPIUS GO 420 LED – Flood

Part No.
988-203

Operational Voltage
9-32

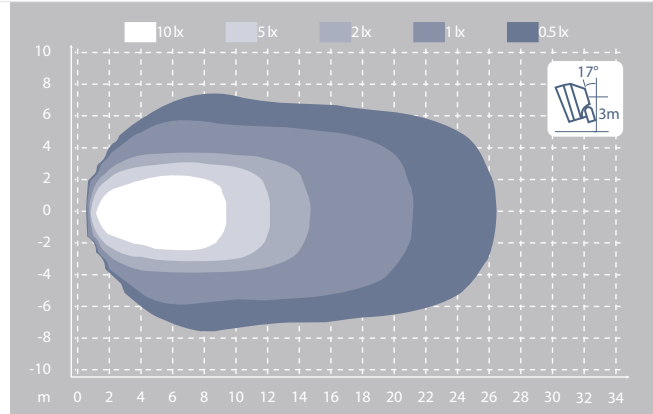

SCORPIUS GO 420 LED – Wide Flood

Part No.
988-204

Operational Voltage
9-32

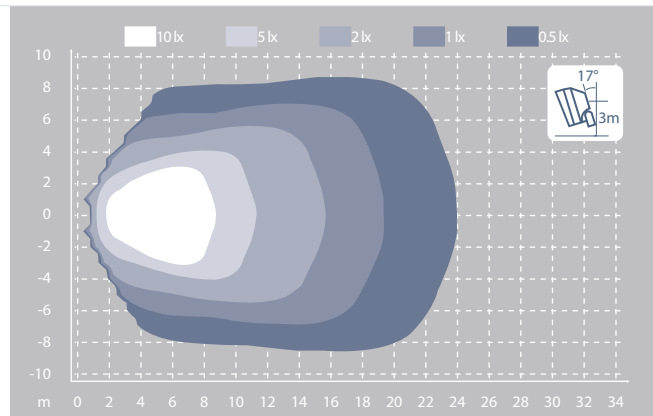

Nordic General Purpose LED

NEW

KL1401 LED



- Cost effective, high quality worklamp.
- Multi-voltage.
- Long life LEDs.
- Low current draw.
- Over voltage, over temperature, spike & polarity protected.
- Environmentally sealed cast alloy body.
- Extreme shock resistance.
- Even light pattern without hotspots.
- Deutsch DT connector encapsulated in body.
- 5 year warranty.

Theoretical Lumen Output :	3200lm
Operating Lumen Output :	2000lm
Operational Voltage :	9-32V
Input Current :	1.7A @ 24V
Max Power Consumption :	40 Watts
LED Lifetime :	50,000 Hrs
Connector :	Deutsch DT Series 2 Pin
Mount :	Single Bolt M10
Shock :	60G
Vibration :	8G rms 24 - 2000Hz
Lens :	PC
Body :	Aluminium
Weight :	0.9kg
Ingress Protection :	IP68, IP6K9K
Salt Mist :	ISO 9227 240H
EMC :	ISO 13766, ISO 14982, ISO 7637-2, EN12895
Operating Temperature :	-40°C to 85°C
Colour Temperature :	5700K
Light Source :	10 x Lumileds® Luxeon Z ES

- 9V 32V
- IP68
- IP 6K9K
- 5Yrs

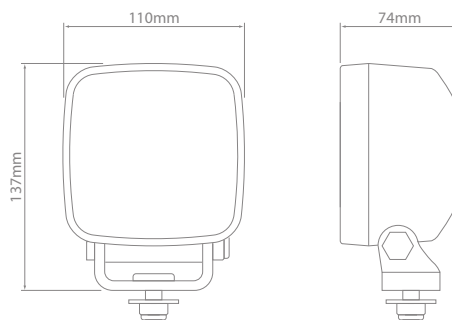

Nordic General Purpose LED

KL1401 LED – Flood

Part No. Operational Voltage
982-804 **9-32**

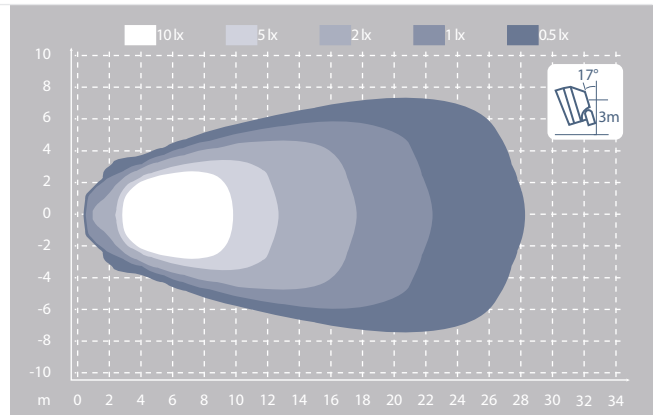

KL1401 LED – Wide Flood

Part No. Operational Voltage
982-803 **9-32**

