

WL2024

WL 2024

Worklamps

ionnic | 

Mission Statement

To become the preferred supplier of electrical, lighting and safety solutions for mobile plant and equipment in the mining and services industry.

We will continue to improve and expand our range of products that meet and exceed OEM standards, maintaining the latest technology and innovation available backed by technical support and supply.



Nordic Heavy Duty LED

SPICA LED N26	10
SPICA LED N2401	12
CANIS LED N2001	14
SCORPIUS LED N4406	16
SCORPIUS LED N4402	18
SCORPIUS PRO LED 445	20
CENTAURUS LED N4601	22
GEMINI LED N4701	24
PICTOR LED N7301	26
SCULPTOR LED N6001	28

Nordic General Purpose LED

KL1901 LED	32
CANIS GO 410 LED	34
KL2001 LED	36
SCORPIUS GO 420 LED	38
KL1401 LED	40

Nordic Heavy Duty HID

N45 HID	44
---------	----

J.W. SPEAKER LED

670 XD Worklamps	48
892 Worklamp	50
526 Worklamps	52
8820 Headlight	54
8700 Evo 2 Pro Headlight	56
793 Safety Light	58
529 Safety Light	59

IONNIC LED Worklamps

8210 LED	63
8220 LED	64
8230 LED	65
8095 LED	66
2100 LED	67
1090 LED	68
LED Scene Light	69

IONNIC LED Driving Lights

Night Ranger 7"	74
Night Ranger 9"	76
Night Ranger SR	78
Night Ranger DR	80
NUUK LED	82

LED Interior Lighting

LED Strip Light	86
LED Strip Lights with Switch	88
Dome Light – Round	90
Dome Light – Rectangular	91

Index

92

What's new in WL2024

NEW in Nordic General Purpose LED

38 SCORPIUS GO 420 LED - Spot



NEW in J.W. SPEAKER LED

48 670 XD Worklamps

50 892 Worklamp

52 526 Worklamps

54 8820 Headlight

56 8700 Evo 2 Pro Headlight

58 793 Safety Light

59 529 Safety Light



What's new in WL2024

NEW in IONNIC LED Worklamps



8210 LED	63
8220 LED	64
8230 LED	65

NEW in IONNIC LED Driving Lights



Night Ranger 7"	74
Night Ranger 9"	76
Night Ranger SR	78
Night Ranger DR	80

NEW in LED Interior Lighting



Dome Light - Round	90
--------------------	----



 **NORDICLIGHTS**

POWERFUL ROBUST











 **NORDICLIGHTS**



Nordic Heavy Duty LED



Nordic Heavy Duty LED

	SPICA LED N26	10
	SPICA LED N2401	12
	CANIS LED N2001	14
	SCORPIUS LED N4406	16
	SCORPIUS LED N4402	18
	SCORPIUS PRO LED 445	20
	CENTAURUS LED N4601	22
	GEMINI LED N4701	24
	PICTOR LED N7301	26
	SCULPTOR LED N6001	28

Nordic Heavy Duty LED

SPICA LED N26



- Extensive multi-voltage.
- Low current draw.
- Over voltage, over temperature, spike & polarity protected.
- Environmentally sealed – IP68, IP69K.
- Extreme shock resistance.
- Robust cast alloy body.
- Heavy duty mount.
- Replaceable lens.
- Rotate lens for pendant or side mount.
- TE DEUTSCH compatible connector encapsulated in body.
- 5-year warranty.

Theoretical Lumen Output :	1,100lm
Operating Lumen Output :	700lm
Operational Voltage :	9–110V
Current Draw :	0.7A @ 24V
Max Power Consumption :	17W
LED Lifetime :	50,000 Hrs
Connector :	DT Style – 2 Pin
Mount :	Single Bolt M10
Shock :	60G
Vibration :	8G rms 24–2000Hz
Lens :	Polycarbonate
Body :	Aluminium
Weight :	0.9kg
Ingress Protection :	IP68, IP6K9K
Salt Mist :	ISO 9227
EMC :	ISO 13766, ISO 14982, ISO 7637-2, EN12895
Operating Temperature :	-40°C to 85°C
Colour Temperature :	5700K
Light Source :	4 x Rebel ES LEDs



Supplied with genuine TE DEUTSCH 2 pin connector

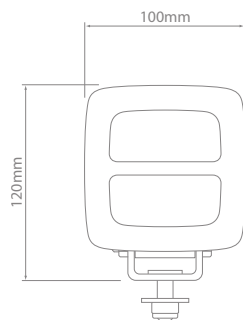
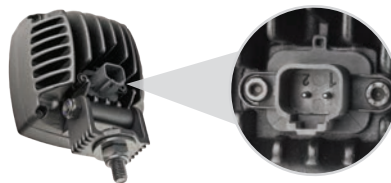

Nordic Heavy Duty LED

SPICA LED N26 – Flood

Part No.

981-202

Operational Voltage

9-110

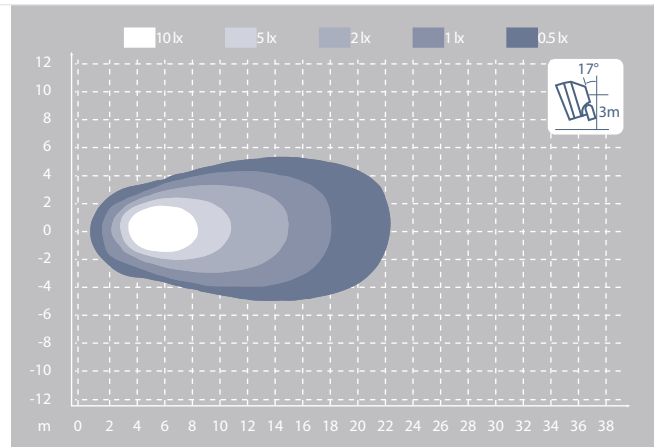

Nordic Heavy Duty LED

SPICA LED N2401



- Multi-voltage.
- Low current draw.
- Over voltage, over temp, spike & polarity protected.
- Environmentally sealed – IP68, IP6K9K.
- Extreme shock resistance.
- Robust cast alloy body.
- Heavy duty mount.
- Replaceable lens.
- Rotate lens for pendant or side mount.
- TE DEUTSCH compatible connector encapsulated in body.
- Handle version with integrated toggle switch and sealing boot, for easy on-site adjustment.
- 5-year warranty.

Theoretical Lumen Output :	1,200lm
Operating Lumen Output :	750lm
Operational Voltage :	9–32V
Current Draw :	1.0A @ 24V
Max Power Consumption :	24W
LED Lifetime :	50,000 Hrs
Connector :	DT Style – 2 Pin
Mount :	Single Bolt M10
Shock :	60G
Vibration :	8G rms 24–2000Hz
Lens :	Polycarbonate
Body :	Aluminium
Weight :	0.9kg
Ingress Protection :	IP68, IP6K9K
Salt Mist :	ISO 9227
EMC :	ISO 13766, ISO 14982, ISO 7637-2, EN12895
Operating Temperature :	-40°C to 85°C
Colour Temperature :	5700K
Light Source :	4 x OSLO [®] Square LEDs

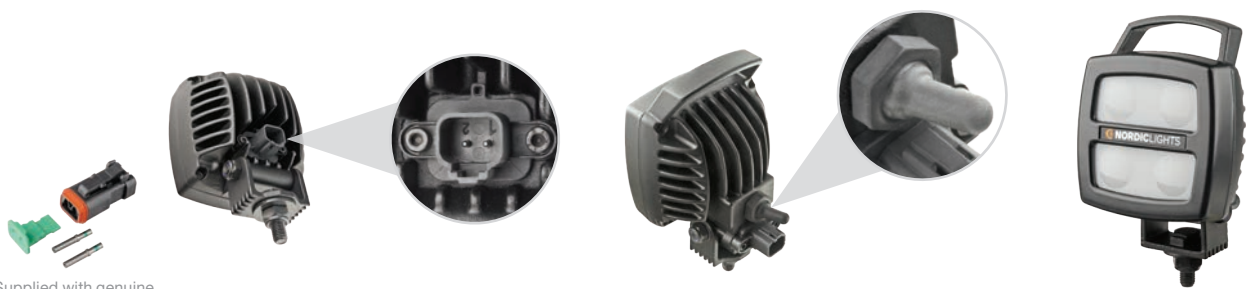

Supplied with genuine TE DEUTSCH 2 pin connector

981-311 Diffused

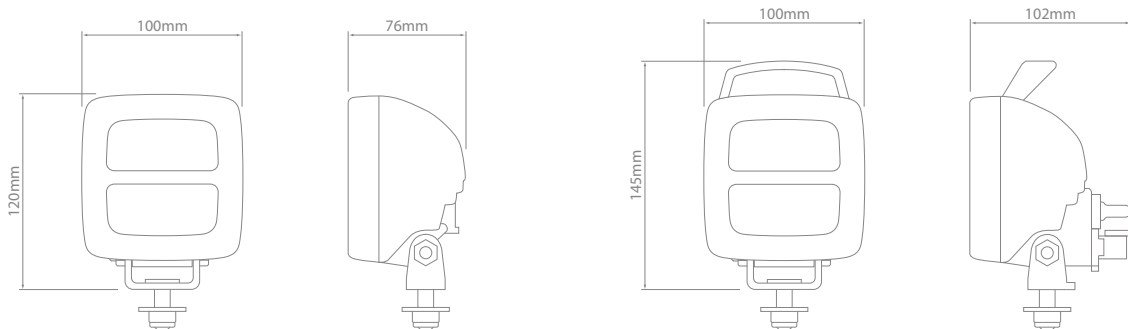

Nordic Heavy Duty LED

SPICA LED N2401 – Flood

Part No.	Operational Voltage	Handle
981-302	9-32	No
981-320	9-32	Yes

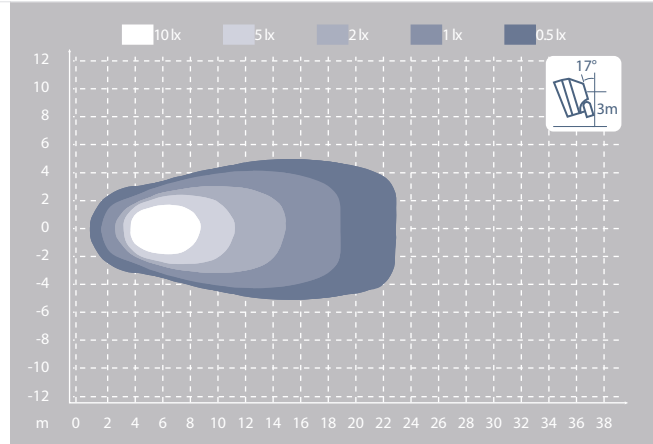

SPICA LED N2401 – Wide Flood

Part No.	Operational Voltage	Handle
981-301	9-32	No
981-319	9-32	Yes

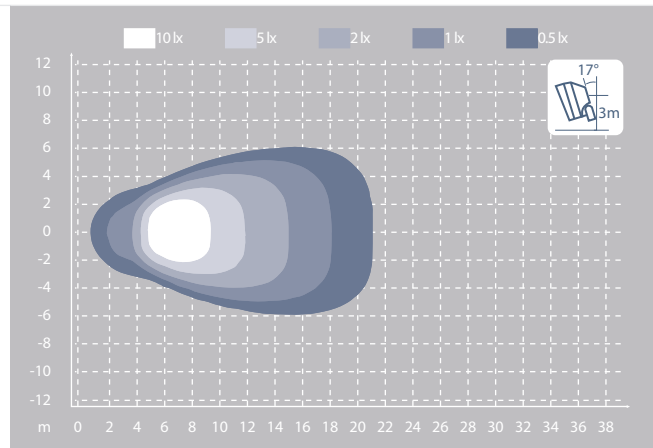

SPICA LED N2401 – Diffused

Part No.	Operational Voltage	Handle
981-311	9-32	Yes

Ideal for enclosed areas & engine compartments.

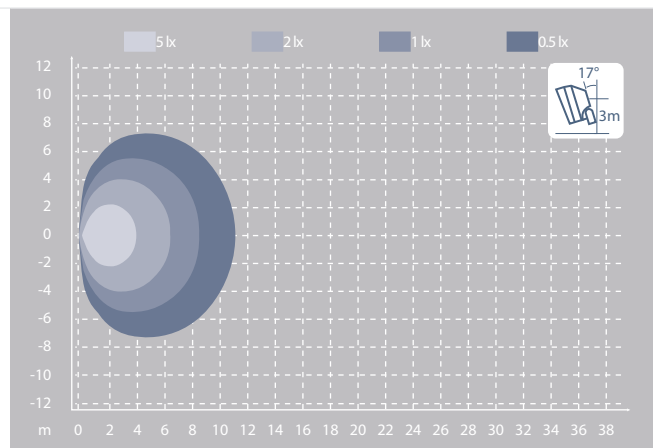

SPICA LED N2401 – Spot

Part No.	Operational Voltage	Handle
981-303	9-32	No
981-318	9-32	Yes

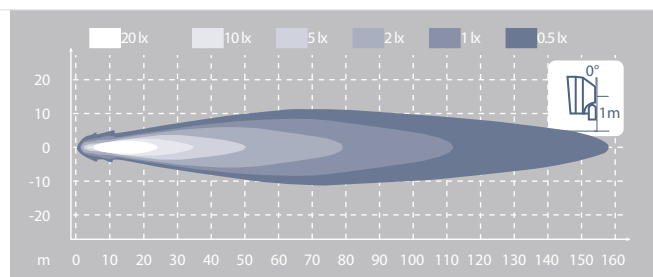

Nordic Heavy Duty LED

CANIS LED N2001



- Ultra compact & lightweight.
- Extensive multi-voltage.
- Extreme shock resistance.
- Over voltage, over temperature, spike & polarity protected.
- Environmentally sealed – IP68, IP6K9K.
- Robust cast alloy body.
- TE DEUTSCH compatible connector encapsulated in body.
- 5-year warranty.

Theoretical Lumen Output :	1,600lm
Operating Lumen Output :	1,000lm
Operational Voltage :	9–68V
Current Draw :	0.25A @ 48V
Max Power Consumption :	13W
LED Lifetime :	50,000 Hrs
Connector :	DT Style – 2 Pin
Mount :	Single Bolt M10
Shock :	60G
Vibration :	15.3G rms 24–2000Hz
Lens :	Polycarbonate
Body :	Aluminium
Weight :	0.6kg
Ingress Protection :	IP68, IP6K9K
Salt Mist :	ISO 9227
EMC :	ISO 13766, ISO 14982, ISO 7637-2
Operating Temperature :	-40°C to 85°C
Colour Temperature :	5700K
Light Source :	Single Lumileds® Luxeon M LED

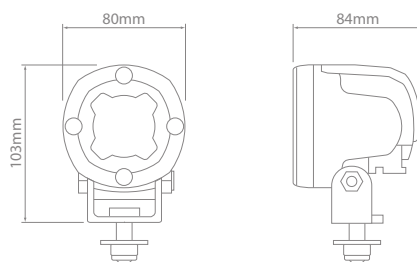

Nordic Heavy Duty LED

CANIS LED N2001 – Wide Flood

Part No.

980-101

Operational Voltage

9-68

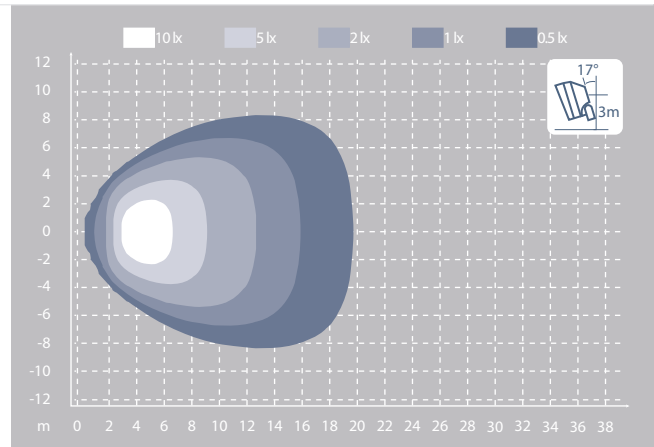

Nordic Heavy Duty LED

SCORPIUS LED N4406



- Multi-voltage.
- Over voltage, over temperature, spike & polarity protected.
- Environmentally sealed – IP68, IP6K9K.
- Extreme shock resistance.
- Robust cast alloy body.
- Heavy duty mount.
- Replaceable lens.
- Rotate lens for pendant mount.
- TE DEUTSCH compatible connector encapsulated in body.
- 5-year warranty.

Theoretical Lumen Output :	3,700lm
Operating Lumen Output :	2,300lm
Operational Voltage :	9–32V
Current Draw :	0.9A @ 24V
Max Power Consumption :	22W
LED Lifetime :	50,000 Hrs
Connector :	DT Style – 2 Pin
Mount :	Single Bolt M10
Shock :	60G
Vibration :	15.3G rms 24–2000Hz
Lens :	Polycarbonate
Body :	Aluminium
Weight :	1.1kg
Ingress Protection :	IP68, IP6K9K
Salt Mist :	ISO 9227 240H
EMC :	ISO 13766, ISO 14982, ISO 7637-2, EN12895
Operating Temperature :	-40°C to 85°C
Colour Temperature :	5700K
Light Source :	10 x Luxeon Rebel LEDs

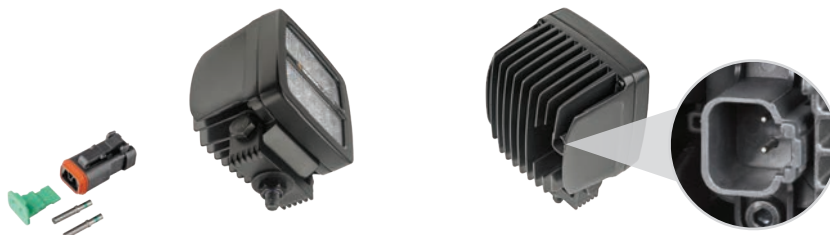

Supplied with genuine TE DEUTSCH 2 pin connector

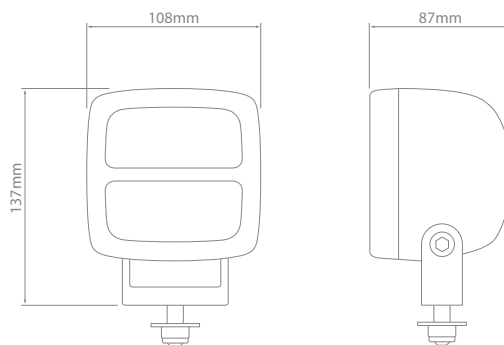

Nordic Heavy Duty LED

SCORPIUS LED N4406 – Flood

Part No. Operational Voltage
984-037 **9-32**

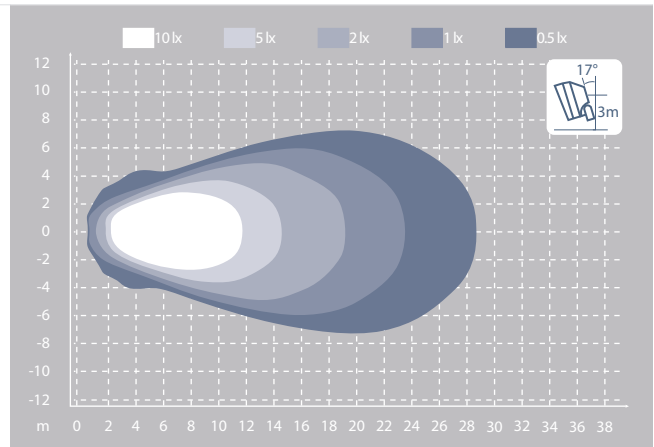

SCORPIUS LED N4406 – Wide Flood

Part No. Operational Voltage
984-036 **9-32**

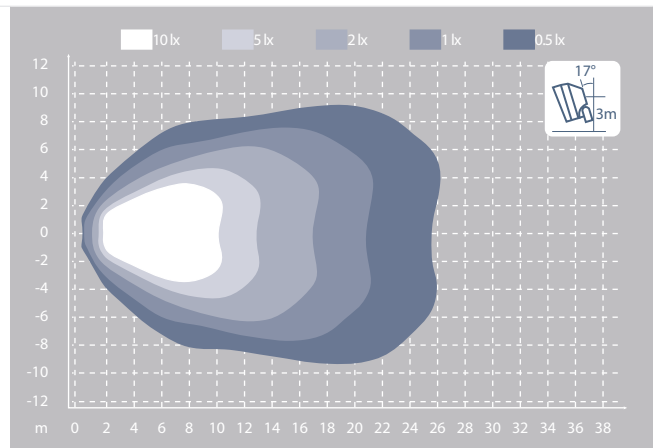

SCORPIUS LED N4406 – Low Beam

Part No. Operational Voltage
984-038 **9-32**

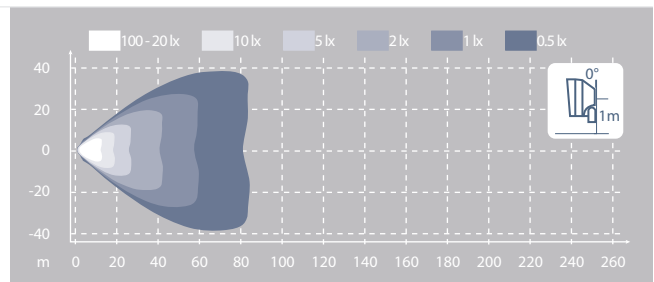

SCORPIUS LED N4406 – High Beam

Part No. Operational Voltage
984-039 **9-32**

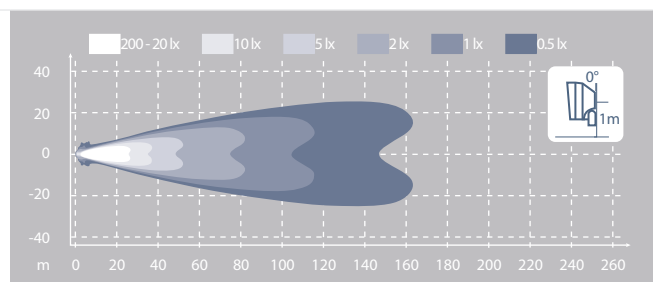

Nordic Heavy Duty LED

SCORPIUS LED N4402



- Multi-voltage.
- Over voltage, over temperature, spike & polarity protected.
- Environmentally sealed – IP68, IP6K9K.
- Extreme shock resistance.
- Robust cast alloy body.
- Heavy duty mount.
- Replaceable lens.
- Rotate lens for pendant mount.
- TE DEUTSCH compatible connector encapsulated in body.
- 5-year warranty.

Theoretical Lumen Output :	6,700lm
Operating Lumen Output :	4,200lm
Operational Voltage :	9–32V
Current Draw :	2.1A @ 24V
Max Power Consumption :	50W
LED Lifetime :	50,000 Hrs
Connector :	DT Style – 2 Pin
Mount :	Single Bolt M10
Shock :	60G
Vibration :	15.3G rms 24–2000Hz
Lens :	Polycarbonate
Body :	Aluminium
Weight :	1.1kg
Ingress Protection :	IP68, IP6K9K
Salt Mist :	ISO 9227 240H
EMC :	ISO 13766, ISO 14982, ISO 7637-2
Operating Temperature :	-40°C to 85°C
Colour Temperature :	5700K
Light Source :	10 x Cree® XML LEDs

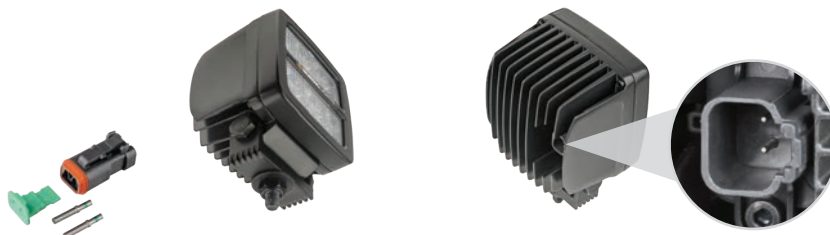

Supplied with genuine TE DEUTSCH 2 pin connector

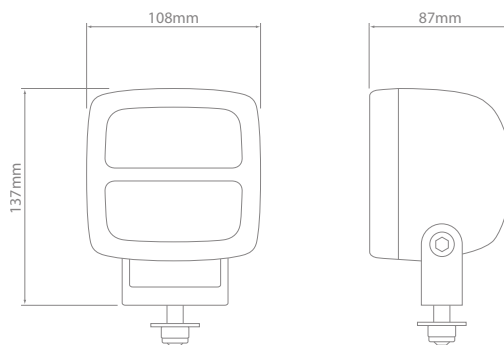

Nordic Heavy Duty LED

SCORPIUS LED N4402 – Flood

Part No. Operational Voltage
984-102 **9-32**

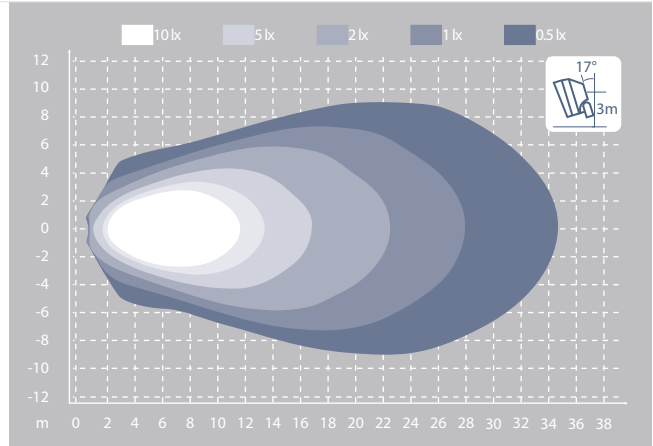

SCORPIUS LED N4402 – Wide Flood

Part No. Operational Voltage
984-101 **9-32**

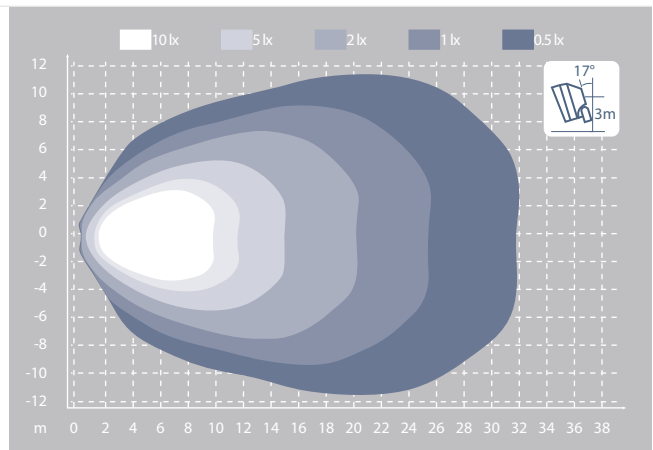

SCORPIUS LED N4402 – Low Beam

Part No. Operational Voltage
984-103 **9-32**

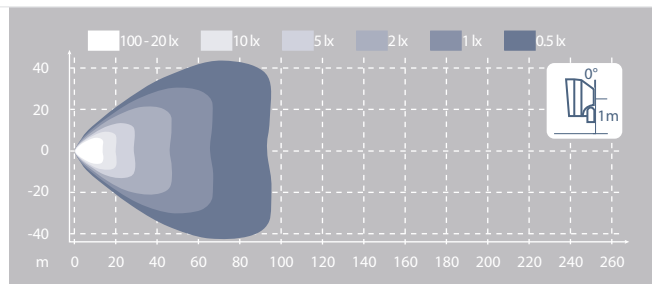

SCORPIUS LED N4402 – High Beam

Part No. Operational Voltage
984-104 **9-32**

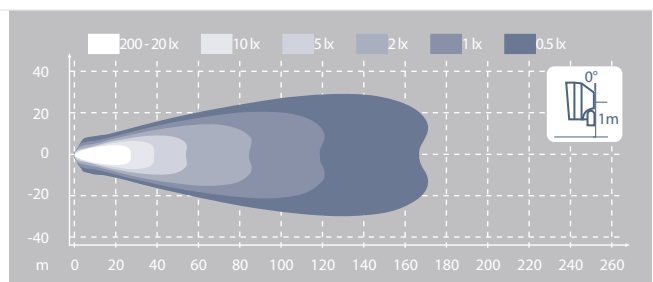

Nordic Heavy Duty LED

SCORPIUS PRO LED 445



- Grilamid® lens for exceptional heat resistance.
- Superior electromagnetic compatibility.
- Latest high output LED technology.
- Multi-voltage.
- Over voltage, over temperature, spike & polarity protected.
- Environmentally sealed – IP68, IP6K9K.
- Extreme shock resistance.
- Robust cast alloy body.
- Heavy duty mount.
- Replaceable lens.
- Rotate lens for pendant mount.
- TE DEUTSCH compatible connector encapsulated in body.
- 5-year warranty.

Theoretical Lumen Output :	7,000lm
Operating Lumen Output :	4,400lm
Operational Voltage :	9–32V
Current Draw :	2.1A @ 24V
Max Power Consumption :	50W
LED Lifetime :	50,000 Hrs
Connector :	DT Style – 2 Pin
Mount :	Single Bolt M10
Shock :	60G
Vibration :	15.3G rms 24–2000Hz
Lens :	Grilamid®
Body :	Aluminium
Weight :	1.1kg
Ingress Protection :	IP68, IP6K9K
Salt Mist :	ISO 9227 240H
EMC :	ISO 13766, ISO 14982, ISO 7637-2
Operating Temperature :	-40°C to 85°C
Colour Temperature :	5000K
Light Source :	14 x Nichia NVSWE21AT LEDs

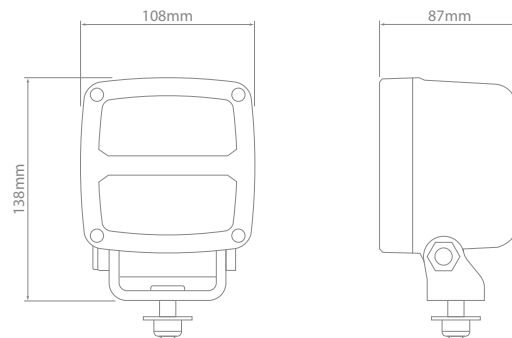

Nordic Heavy Duty LED

SCORPIUS PRO 445 – Flood

Part No. Operational Voltage
984-701 **9-32**

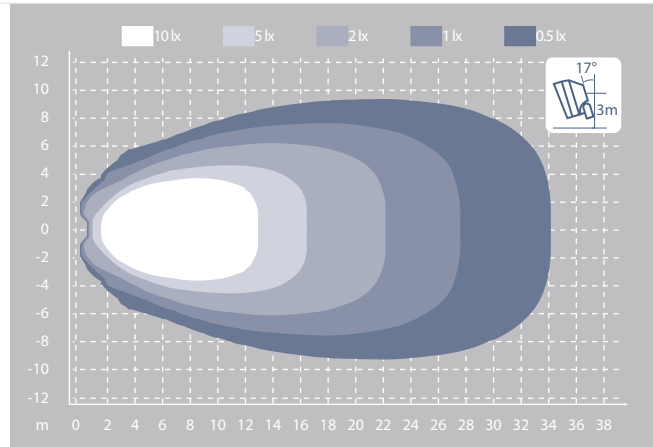

SCORPIUS PRO 445 – Wide Flood

Part No. Operational Voltage
984-703 **9-32**

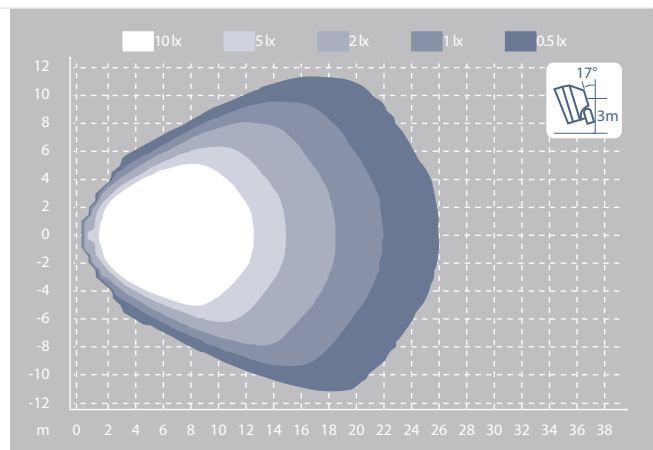

SCORPIUS PRO 445 – Ultra-Wide Flood

Part No. Operational Voltage
984-702 **9-32**

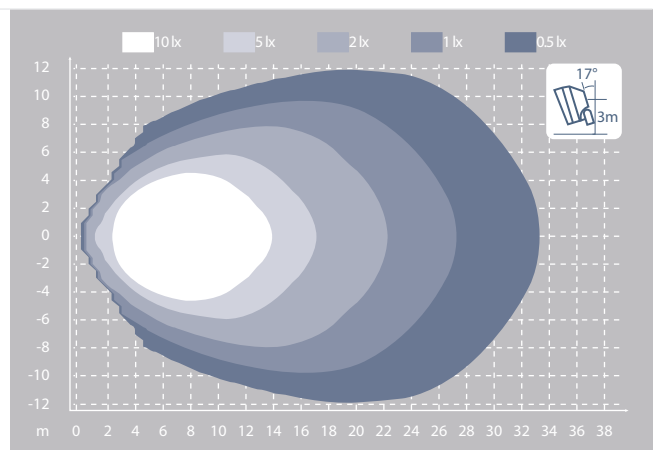

SCORPIUS PRO 445 – Spot

Part No. Operational Voltage
984-704 **9-32**

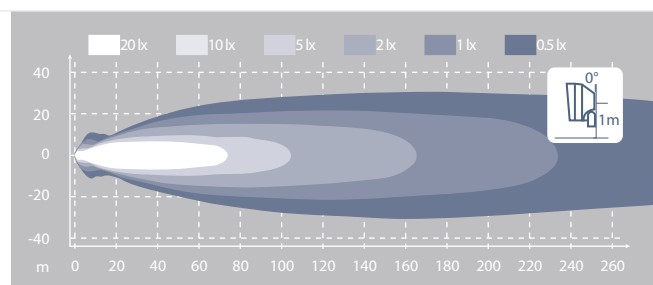

Nordic Heavy Duty LED

CENTAURUS LED N4601



- Superior illumination – 11,500lm.
- Heavy duty QUAKE anti-vibration mounting system.
- Extreme shock resistance.
- Multi-voltage.
- Over voltage, over temperature, spike & polarity protected.
- Environmentally sealed – IP68, IP6K9K.
- Robust cast alloy body.
- TE DEUTSCH compatible connector encapsulated in body.
- 5-year warranty.

Theoretical Lumen Output :	11,500lm
Operating Lumen Output :	7,200lm
Operational Voltage :	18–32V
Current Draw :	3.5A @ 24V
Max Power Consumption :	85W
LED Lifetime :	50,000 Hrs
Connector :	DT Style – 2 Pin
Mount :	Single Bolt M10
Shock :	60G
Vibration :	15.3G rms 24–2000Hz
Lens :	Polycarbonate
Body :	Aluminium
Weight :	2.5kg
Ingress Protection :	IP68, IP6K9K
Salt Mist :	ISO 9227
EMC :	ISO 13766, ISO 14982, ISO 7637-2
Operating Temperature :	-40°C to 85°C
Colour Temperature :	5700K
Light Source :	8 x Lumileds® Luxeon M LEDs



QUAKE Mounting System

The Nordic CENTAURUS LED N4601 worklamp features the revolutionary patented QUAKE heavy duty mounting system. Incorporating 4 dampeners angled toward the centre axis of the worklamp body, precisely calculated and set to the optimal angle to allow greater shock and vibration resistance.

The angled nature of the dampeners in the QUAKE heavy duty mounting system results in a lower overall height compared to standard mounting systems.

With this system, a worklamp will last longer and can withstand much more punishment reducing maintenance and downtime.



Supplied with genuine TE DEUTSCH 2 pin connector

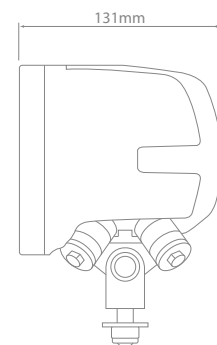
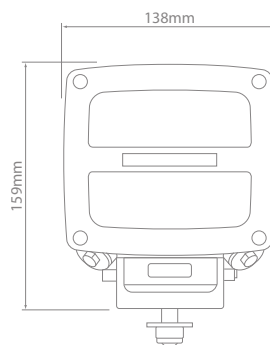

Nordic Heavy Duty LED

CENTAURUS LED N4601 – Flood

Part No. Operational Voltage
986-102 18-32

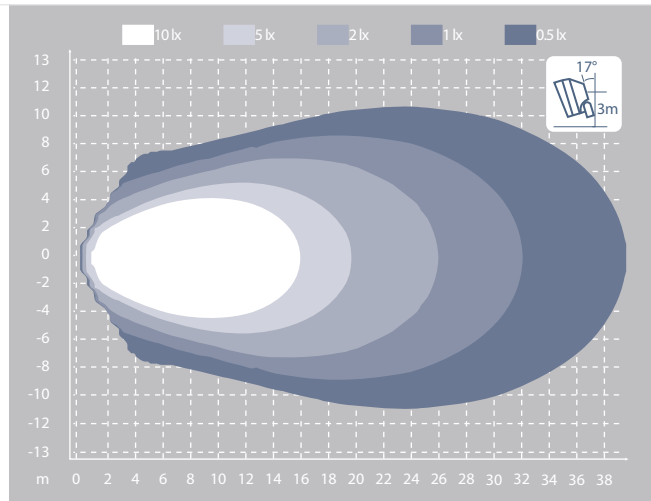

CENTAURUS LED N4601 – Wide Flood

Part No. Operational Voltage
986-101 18-32

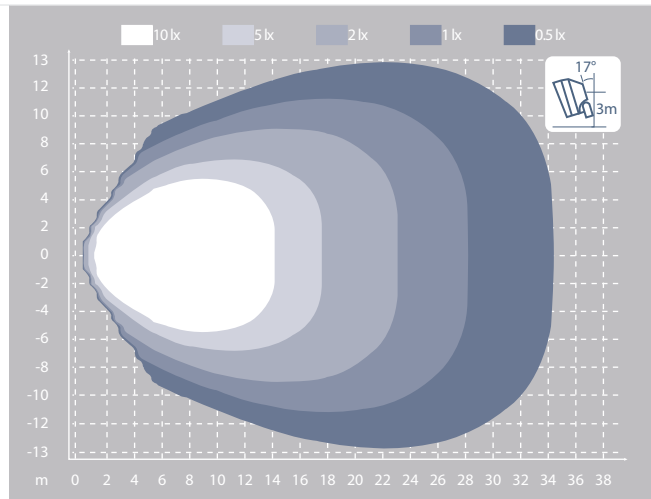

CENTAURUS LED N4601 – Low Beam

Part No. Operational Voltage
986-103 18-32

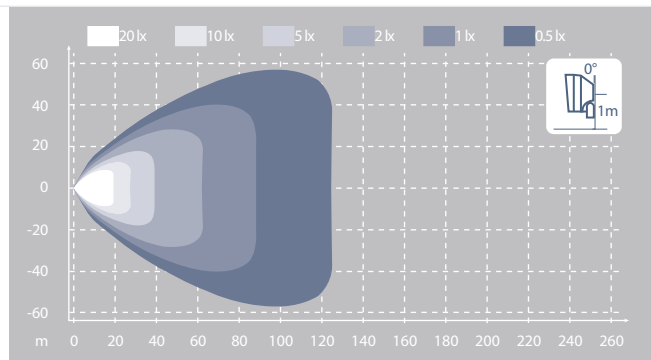

CENTAURUS LED N4601 – Spot*

Part No. Operational Voltage
986-104 18-32

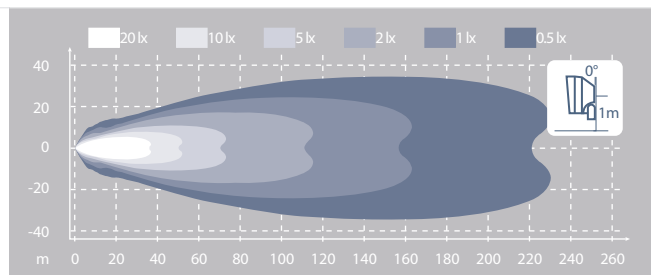

*Not recommended for high beam due to extreme brightness.



Nordic Heavy Duty LED

GEMINI LED N4701



- Ultimate illumination – 40,300lm.
- Over voltage, over temperature, spike & polarity protected.
- Environmentally sealed– IP68, IP6K9K.
- Replaceable lens.
- Individual connector for upper & lower lamps.
- Robust cast alloy body.
- TE DEUTSCH compatible connectors encapsulated in body.
- 5-year warranty.

Theoretical Lumen Output :	40,300lm
Operating Lumen Output :	25,200lm
Operational Voltage :	18-32V
Current Draw :	12.5A @ 24V
Max Power Consumption :	300W
LED Lifetime :	50,000 Hrs
Connectors :	2 x DT Style – 2 Pin
Mount :	5 x M14 Bolt
Lens :	Polycarbonate
Body :	Aluminium
Weight :	18kg
Ingress Protection :	IP68, IP6K9K
Salt Mist :	ISO 9227
EMC :	ISO 13766, ISO 14982, ISO 7637-2
Operating Temperature :	-40°C to 85°C
Colour Temperature :	5700K
Light Source :	60 x Cree® XML-2 LEDs

Non stocked item, lead times apply

- 18V
32V
- IP68
- IP
6K9K
- 5Yrs



Supplied with genuine TE DEUTSCH 2 pin connectors

Nordic Heavy Duty LED

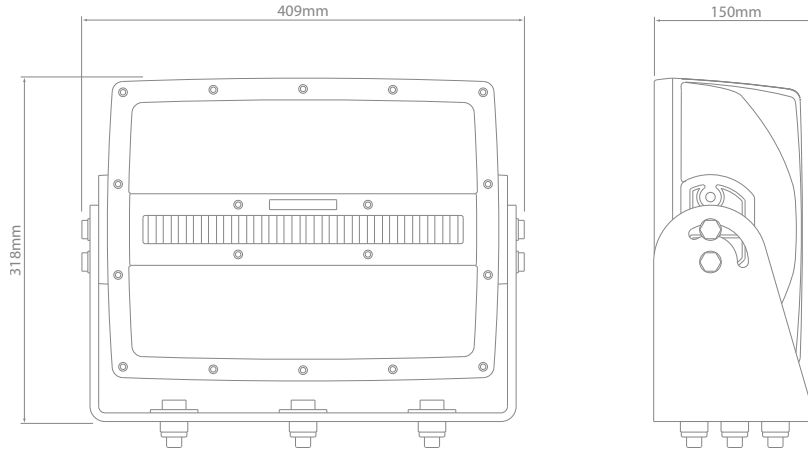

GEMINI LED N4701 – Flood

Part No. Voltage
984-401 18-32

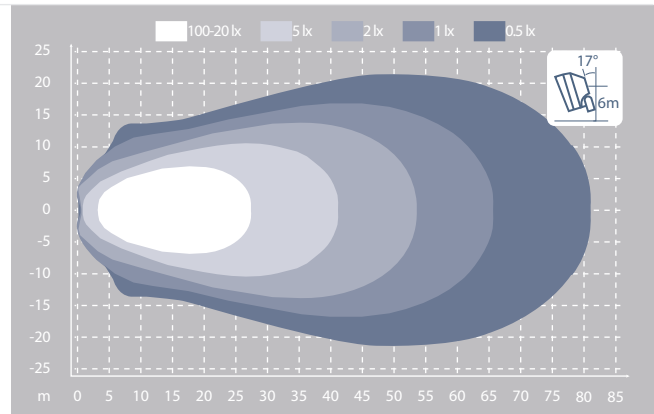

GEMINI LED N4701 – Spot*

Part No. Voltage
984-402 18-32

*Not recommended for high beam due to extreme brightness.

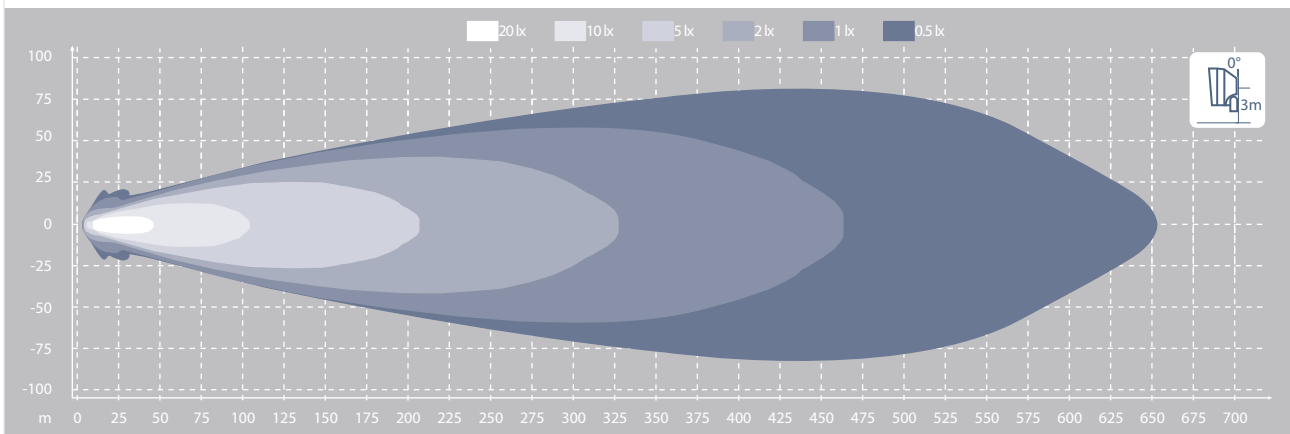

Nordic Heavy Duty LED

PICTOR LED N7301



- Compact & low profile design.
- Up-Side or Down-Side light dispersion models.
- Multi-voltage.
- Over voltage, over temperature, spike & polarity protected.
- Environmentally sealed – IP68, IP6K9K.
- Extreme shock resistance.
- Replaceable lens.
- Robust cast alloy body.
- TE DEUTSCH compatible connector encapsulated in body.
- Ideal for mining, forestry, construction and material handling application.
- Can be mounted on sides of excavator boom.
- 5-year warranty.

Theoretical Lumen Output :	4,100lm
Operating Lumen Output :	2,600lm
Operational Voltage :	9–32V
Current Draw :	1.3A @ 24V
Max Power Consumption :	32W
LED Lifetime :	50,000 Hrs
Connectors :	DT Style – 2 Pin
Mount :	<i>user supplied</i> 4 x M8 Bolt
Shock :	60G
Vibration :	15.3G rms 24–2000Hz
Lens :	Polycarbonate
Body :	Aluminium
Weight :	1.6kg
Ingress Protection :	IP68, IP6K9K
Salt Mist :	ISO 9227
EMC :	ISO 13766, ISO 14982, ISO 7637-2
Operating Temperature :	-40°C to 85°C
Colour Temperature :	5700K
Light Source :	6 x Cree® XML-2 LEDs

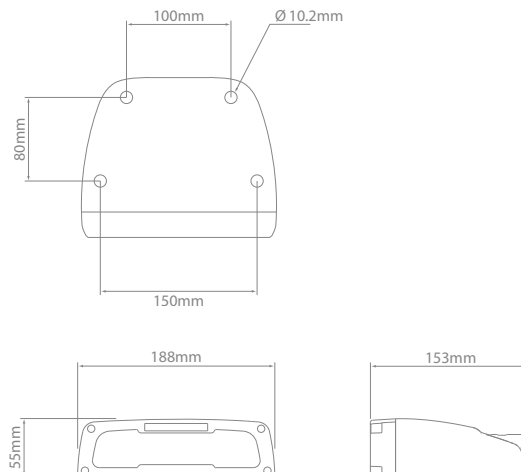

Nordic Heavy Duty LED

Light Distribution

The Nordic PICTOR LED N7301 Worklamp is available in two light patterns – Up-Side or Down-Side. The Up-Side light pattern is diametrically opposed to the Down-Side pattern. Depending on the position and orientation of the mounted worklamp, one light pattern will be more appropriate than the other.

Up-Side light dispersion version



Light is illuminating toward upper side of the worklamp

Down-Side light dispersion version



Light is illuminating toward down side of the worklamp

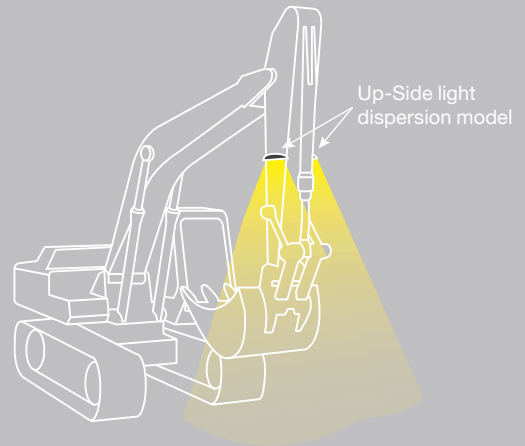

PICTOR LED N7301 – Flood

Part No.	Operational Voltage	Light Distribution
987-101	9-32	Up-Side
987-102	9-32	Down-Side

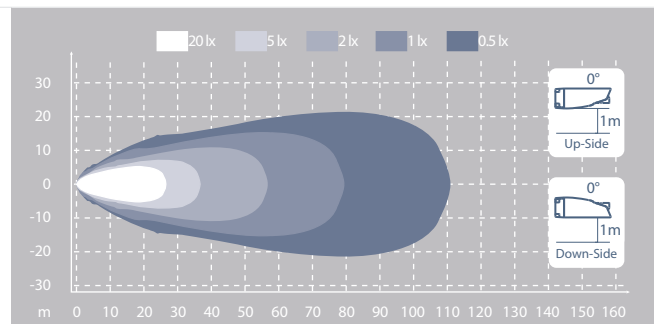

Nordic Heavy Duty LED

SCULPTOR LED N6001



- Complete headlight system incorporating high beam, low beam, indicator and park light.
- Complies to ADR when positioned correctly on the vehicle.
- Single bolt mount with over 120° of articulation.
- Heavy duty QUAKE anti-vibration mounting system.
- Multi-voltage.
- Over voltage, over temperature, spike & polarity protected.
- Environmentally sealed – IP68, IP6K9K.
- Extreme shock resistance.
- Robust cast alloy body.
- TE DEUTSCH compatible connector encapsulated in body.
- 2-year warranty.

Operational Voltage :	9–32V
Max Power Consumption :	High Beam 34W Low Beam 17W
LED Lifetime :	50,000 Hrs
Connector :	DT Style – 6 Pin
Mount :	Single Bolt M10 – Articulated
Shock :	60G
Vibration :	15.3 Grms 24–2000Hz
Lens :	Polycarbonate
Body :	Aluminium
Weight :	2.5kg
Salt Mist :	ISO 9227 240H
Approvals :	CE, ECE, ADR
Operating Temperature :	-40°C to 85°C
Colour Temperature :	5700K
H/Lamp :	2 x Lumileds® Luxeon Altilon
Indicator :	4 x Lumileds® Luxeon Rebel
Park :	2 x Lumileds® Luxeon Rebel
Ingress Protection :	IP68, IP6K9K

- 9V 32V
- IP68
- IP 6K9K
- 2Yrs
- ADR Approved

Heavy duty QUAKE anti-vibration mounting system



Supplied with genuine TE DEUTSCH 6 pin connector

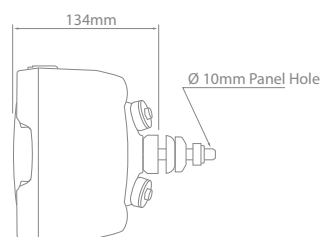
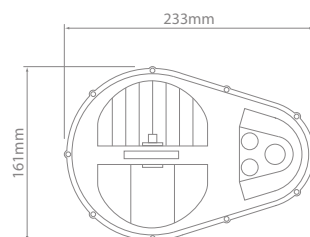

Nordic Heavy Duty LED

Shock & Vibration

Shock and vibration is a major source of damage to worklamps, causing either structural damage or resulting in electrical component failure.

All Nordic Lights worklamps are put through extensive vibration testing in their own state-of-the-art laboratories using an electrodynamic test machine. This in-house testing ensures the entire product range is designed and manufactured to maintain a high working efficiency and long life under the most difficult and demanding of working environments.



SCULPTOR LED N6001

Part No.	Operational Voltage	Position
960-005	9-32	Right
960-006	9-32	Left

Light patterns shown below are of a single headlamp.

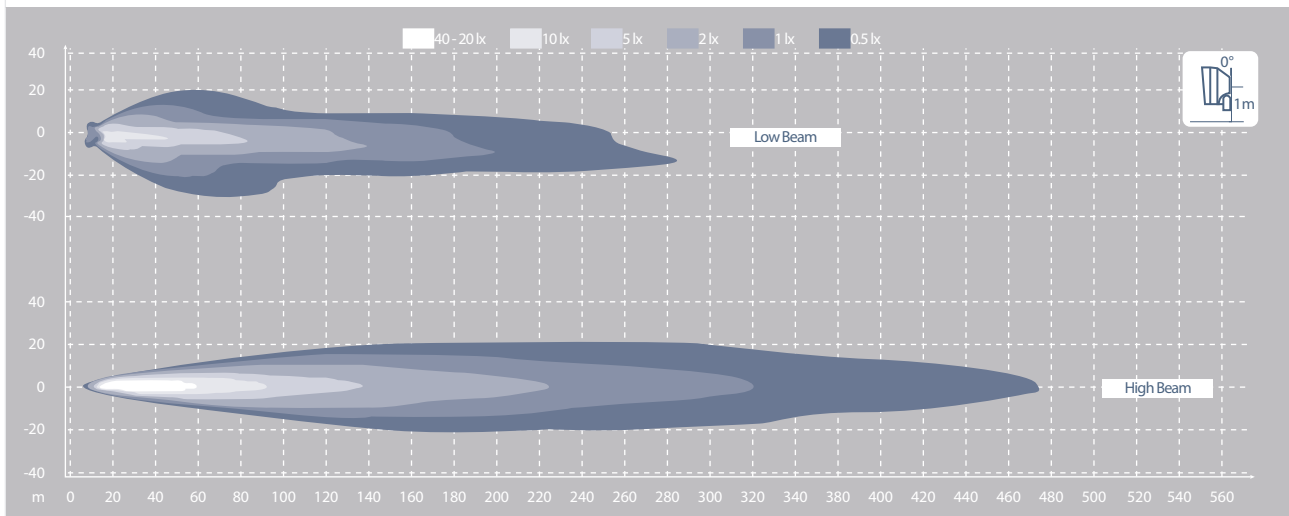

Nordic General Purpose LED



Nordic General Purpose LED



KL1901 LED 32



CANIS GO 410 LED 34



KL2001 LED 36



SCORPIUS GO 420 LED 38



KL1401 LED 40

Nordic General Purpose LED

KL1901 LED



- Cost effective, high quality worklamp.
- Compact design.
- Grilamid® lens for exceptional heat resistance.
- Multi-voltage.
- Low current draw.
- Over voltage, over temperature, spike & polarity protected.
- Environmentally sealed – IP68, IP6K9K.
- Even light pattern without hotspots.
- Robust cast alloy body.
- TE DEUTSCH compatible connector encapsulated in body.
- 5-year warranty.

Theoretical Lumen Output :	1,500lm
Operating Lumen Output :	1,000lm
Operational Voltage :	9–32V
Current Draw :	0.7A @ 24V
Max Power Consumption :	19W
LED Lifetime :	50,000 Hrs
Connector :	DT Style – 2 Pin
Mount :	Single Bolt M8
Shock :	60G
Vibration :	8G rms 24–2000Hz
Lens :	Grilamid®
Body :	Aluminium
Weight :	0.5kg
Ingress Protection :	IP68, IP6K9K
Salt Mist :	ISO 9227 240H
EMC :	ISO 13766, ISO 14982, ISO 7637-2, EN12895
Operating Temperature :	-40°C to 85°C
Colour Temperature :	5700K
Light Source :	6 x Nichia® NCSWE17AT

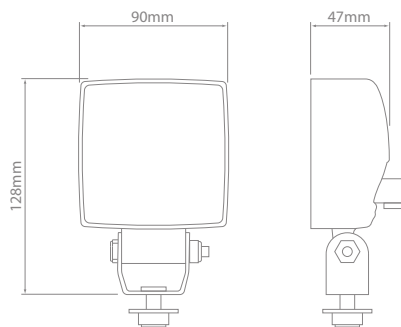

Nordic General Purpose LED

KL1901 LED – Flood

Part No.

988-408

Operational Voltage

9-32

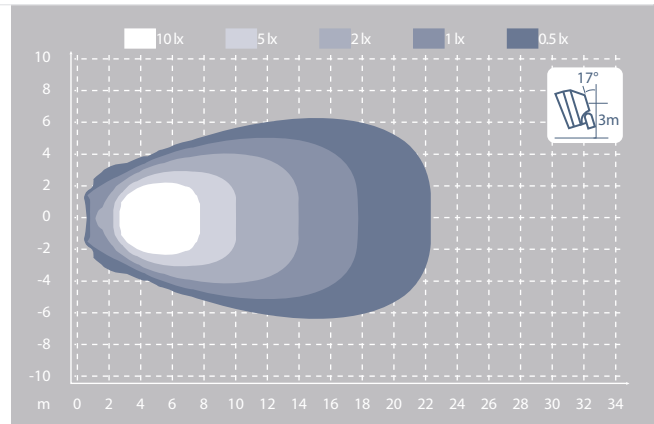

Nordic General Purpose LED

CANIS GO 410 LED



- Cost effective, high quality worklamp.
- Compact design.
- Multi-voltage.
- Low current draw.
- Over voltage, over temperature, spike & polarity protected.
- Environmentally sealed – IP68, IP6K9K.
- Extreme shock resistance.
- Even light pattern without hotspots.
- Robust cast alloy body.
- TE DEUTSCH compatible connector encapsulated in body.
- 5-year warranty.

Theoretical Lumen Output :	1,900lm
Operating Lumen Output :	1,200lm
Operational Voltage :	9–32V
Current Draw :	0.6A @ 24V
Max Power Consumption :	18W
LED Lifetime :	50,000 Hrs
Connector :	DT Style – 2 Pin
Mount :	Single Bolt M8
Shock :	60G
Vibration :	8G rms 24–2000Hz
Lens :	Polycarbonate
Body :	Aluminium
Weight :	0.5kg
Ingress Protection :	IP68, IP6K9K
Salt Mist :	ISO 9227 240H
EMC :	ISO 13766, ISO 14982, ISO 7637-2, EN12895
Operating Temperature :	-40°C to 85°C
Colour Temperature :	5000K
Light Source :	6 x Nichia® NCSWE17AT

- 9V
32V
- IP68
- IP
6K9K
- 5Yrs

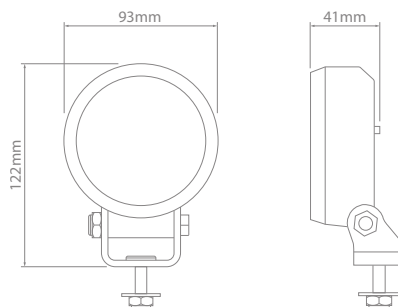

Nordic General Purpose LED

CANIS GO 410 LED – Flood

Part No. Operational Voltage
988-102 **9-32**

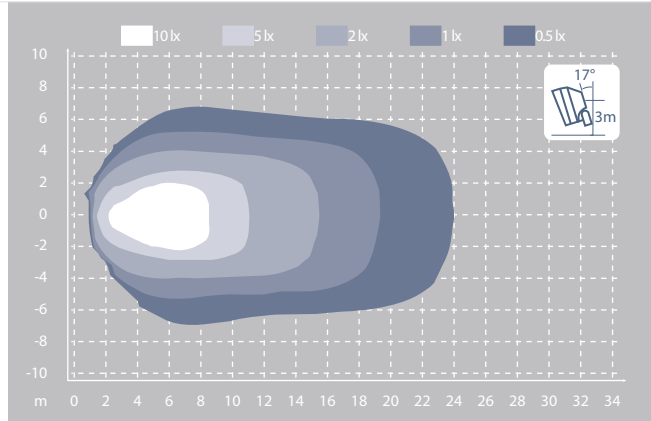

CANIS GO 410 LED – Wide Flood

Part No. Operational Voltage
988-101 **9-32**

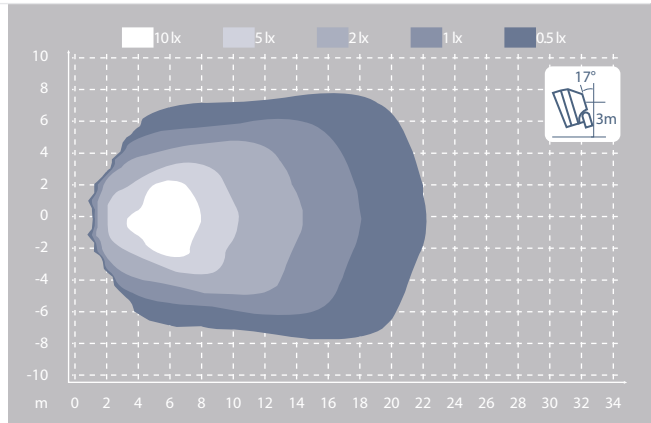

IONNIC Minebars

The Nordic GO 410 LED Worklamp now available as an option on the latest IONNIC Minebars.

For further information on the entire range of IONNIC Minebars, download the complete Emergency Lighting catalogue from ionnic.com or contact your nearest reseller.



Nordic General Purpose LED

KL2001 LED



- Cost effective, high quality worklamp.
- Compact design.
- Multi-voltage.
- Low current draw.
- Over voltage, over temperature, spike & polarity protected.
- Environmentally sealed – IP68, IP6K9K.
- Extreme shock resistance.
- Even light pattern without hotspots.
- Robust cast alloy body.
- TE DEUTSCH compatible connector encapsulated in body.
- 5-year warranty.

Theoretical Lumen Output :	1,900lm
Operating Lumen Output :	1,200lm
Operational Voltage :	9–32V
Current Draw :	0.8A @ 24V
Max Power Consumption :	20W
LED Lifetime :	50,000 Hrs
Connector :	DT Style – 2 Pin
Mount :	Single Bolt M8
Shock :	60G
Vibration :	8G rms 24–2000Hz
Lens :	Polycarbonate
Body :	Aluminium
Weight :	0.5kg
Ingress Protection :	IP68, IP6K9K
Salt Mist :	ISO 9227 240H
EMC :	ISO 13766, ISO 14982, ISO 7637-2, EN12895
Operating Temperature :	-40°C to 85°C
Colour Temperature :	5700K
Light Source :	6 x Lumileds® Luxeon Z ES

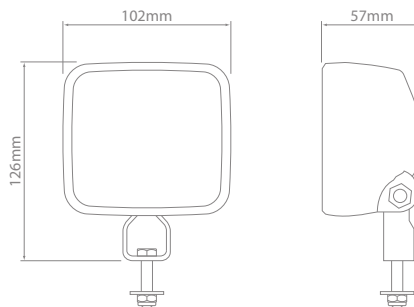
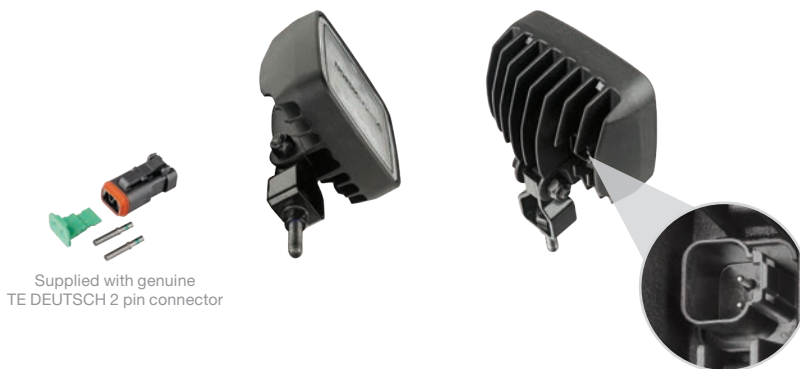

Nordic General Purpose LED

KL2001 LED – Flood

Part No. Operational Voltage
982-609 **9-32**

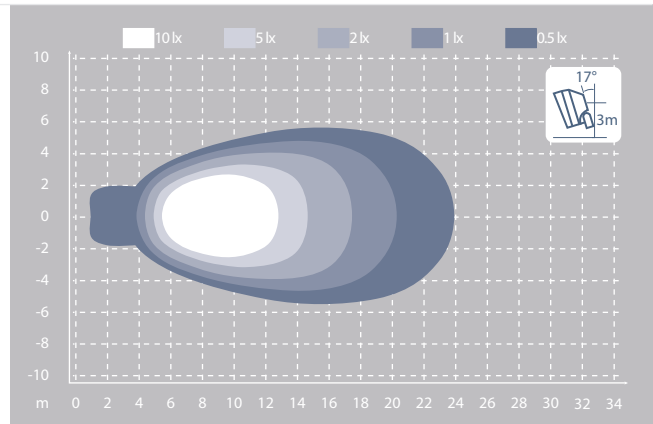

KL2001 LED – Wide Flood

Part No. Operational Voltage
982-608 **9-32**

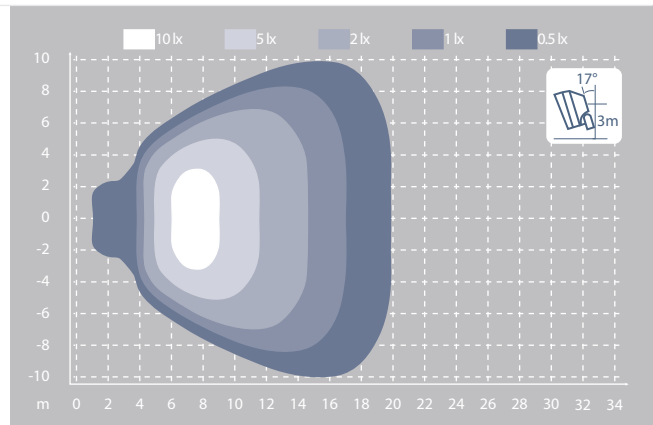

Nordic General Purpose LED

SCORPIUS GO 420 LED



- Cost effective, high quality worklamp.
- Compact design.
- Multi-voltage.
- Low current draw.
- Over voltage, over temperature, spike & polarity protected.
- Environmentally sealed – IP68, IP6K9K.
- Extreme shock resistance.
- Even light pattern without hotspots.
- Robust cast alloy body.
- TE DEUTSCH compatible connector encapsulated in body.
- 5-year warranty.

Theoretical Lumen Output :	3,000lm
Operating Lumen Output :	2,000lm
Operational Voltage :	9–32V
Current Draw :	1.05A @ 24V
Max Power Consumption :	29W
LED Lifetime :	50,000 Hrs
Connector :	DT Style – 2 Pin
Mount :	Single Bolt M8
Shock :	60G
Vibration :	8G rms 24–2000Hz
Lens :	Polycarbonate
Body :	Aluminium
Weight :	0.6kg
Ingress Protection :	IP68, IP6K9K
Salt Mist :	ISO 9227 240H
EMC :	ISO 13766, ISO 14982, ISO 7637-2, EN12895
Operating Temperature :	-40°C to 85°C
Colour Temperature :	5000K
Light Source :	6 x Nichia® NVSWE21AT

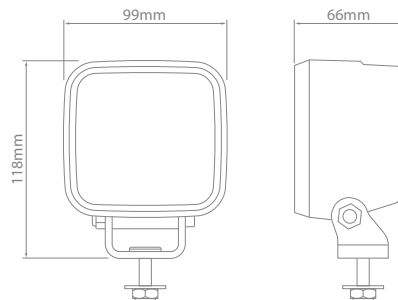

Nordic General Purpose LED

SCORPIUS GO 420 LED – Flood

Part No. Operational Voltage
988-203 9-32

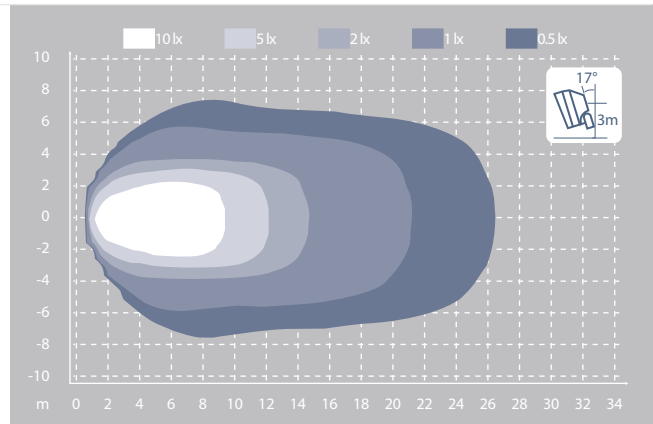

SCORPIUS GO 420 LED – Wide Flood

Part No. Operational Voltage
988-204 9-32

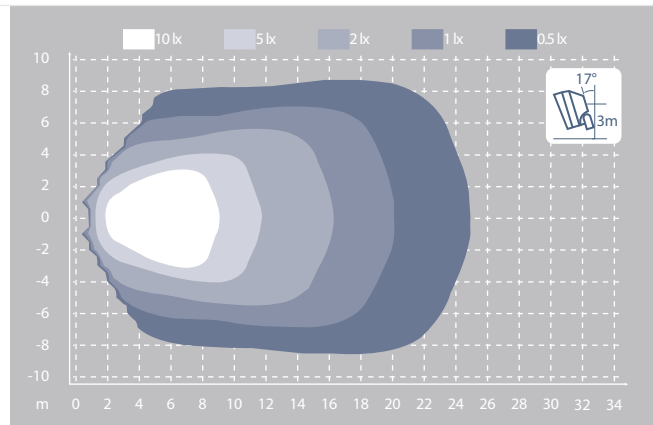

SCORPIUS GO 420 LED – Spot NEW

Part No. Operational Voltage
988-297 9-32

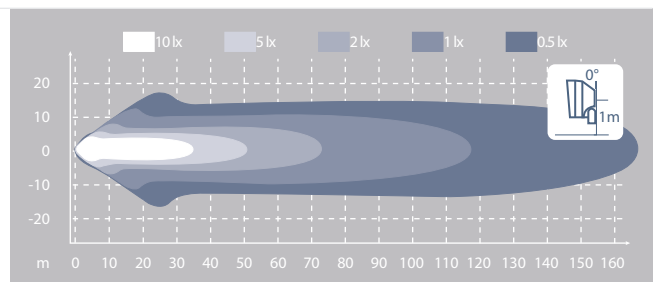

Nordic General Purpose LED

KL1401 LED



- Cost effective, high quality worklamp.
- Multi-voltage.
- Low current draw.
- Over voltage, over temperature, spike & polarity protected.
- Environmentally sealed – IP68, IP6K9K.
- Extreme shock resistance.
- Robust cast alloy body.
- Even light pattern without hotspots.
- TE DEUTSCH compatible connector encapsulated in body.
- 5-year warranty.

Theoretical Lumen Output :	3,200lm
Operating Lumen Output :	2,150lm
Operational Voltage :	9–32V
Current Draw :	1.7A @ 24V
Max Power Consumption :	42W
LED Lifetime :	50,000 Hrs
Connector :	DT Style – 2 Pin
Mount :	Single Bolt M10
Shock :	60G
Vibration :	8G rms 24–2000Hz
Lens :	Polycarbonate
Body :	Aluminium
Weight :	0.9kg
Ingress Protection :	IP68, IP6K9K
Salt Mist :	ISO 9227 240H
EMC :	ISO 13766, ISO 14982, ISO 7637-2, EN12895
Operating Temperature :	-40°C to 85°C
Colour Temperature :	5700K
Light Source :	10 x Lumileds® Luxeon Z ES

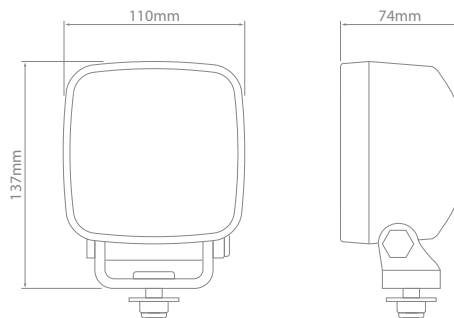
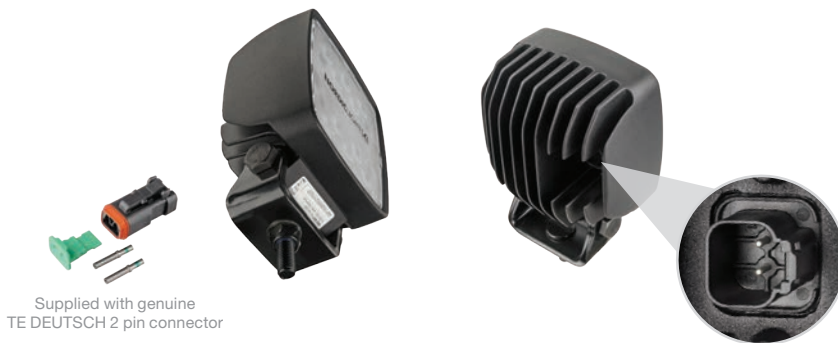

Nordic General Purpose LED

KL1401 LED – Flood

Part No. Operational Voltage
982-804 **9-32**

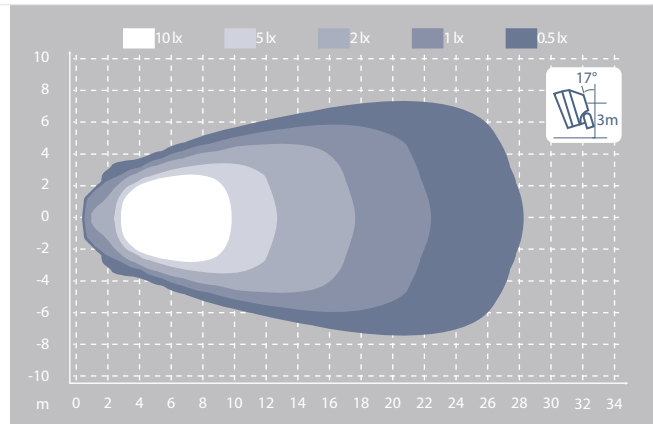

KL1401 LED – Wide Flood

Part No. Operational Voltage
982-803 **9-32**

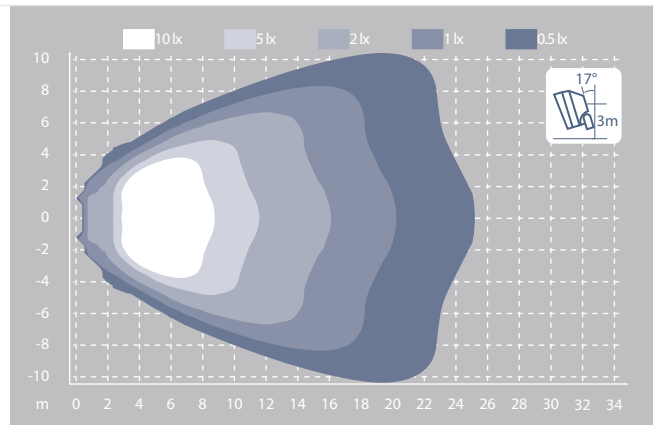

Nordic Heavy Duty HID



Nordic Heavy Duty HID



N45 HID 44

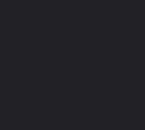

Nordic Heavy Duty HID

N445 HID



- High output 45W ballast produces 60% more light compared to standard ballasts.
- Heavy duty Xenon discharge bulb.
- Low current draw.
- Over voltage, over temperature, spike & polarity protected.
- Heavy duty anti-vibration mounting system.
- Free-Form optics for superior light dispersion.
- Replaceable lens.
- Rotate lens for pendant mount.
- Environmentally sealed cast alloy body.
- Breather filter protects against water and dust ingress.
- Ballast encapsulated in body.
- TE DEUTSCH compatible connector encapsulated in body.

Voltage :	12V
Start Up :	8A
Current Draw :	3A
Ballast :	45W Integrated
Connector :	DT Style – 2 Pin
Mount :	Single Bolt M10
Shock :	50G
Vibration :	20G rms 24–2000Hz
Lens :	Hardened Glass
Body :	Aluminium
Weight :	1.2kg
Ingress Protection :	IP68, IP6K9K
Salt Mist :	ISO 9227
EMC :	ISO 13766
Operating Temperature :	-40°C to 85°C
Colour Temperature :	4250K
Tube :	35W D1S



Supplied with genuine TE DEUTSCH 2 pin connector

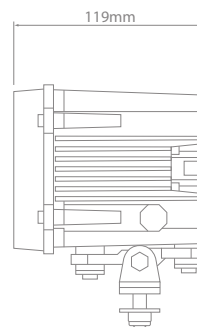
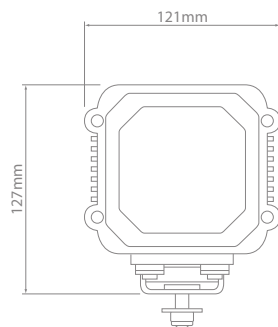
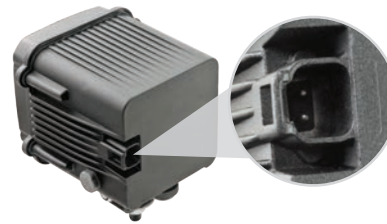

Nordic Heavy Duty HID

N45 HID – Flood

Part No. Voltage
990-058 12

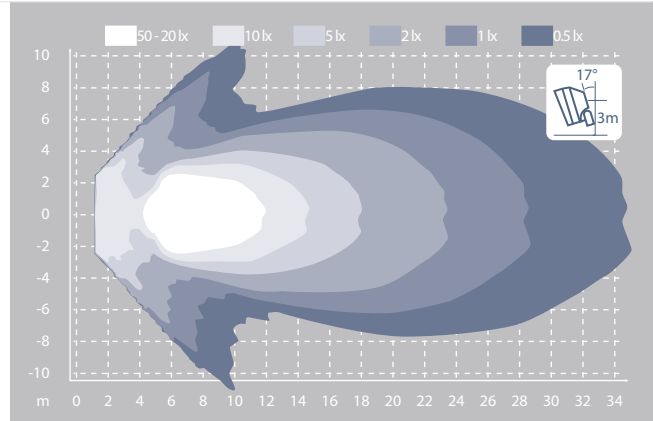

N45 HID – Wide Flood

Part No. Voltage
990-054 12

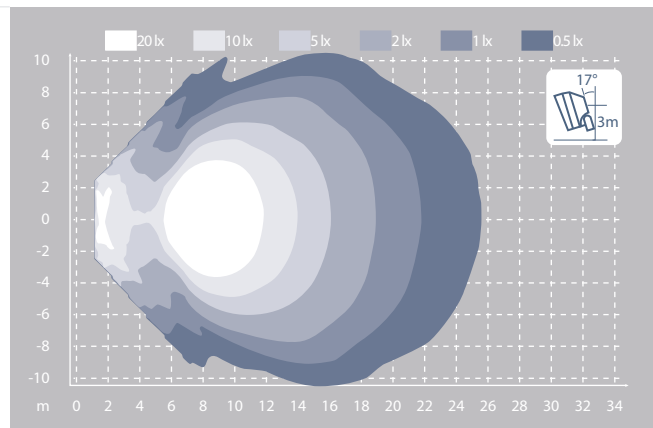

N45 HID – High Beam (Spot)

Part No. Voltage
990-059 12

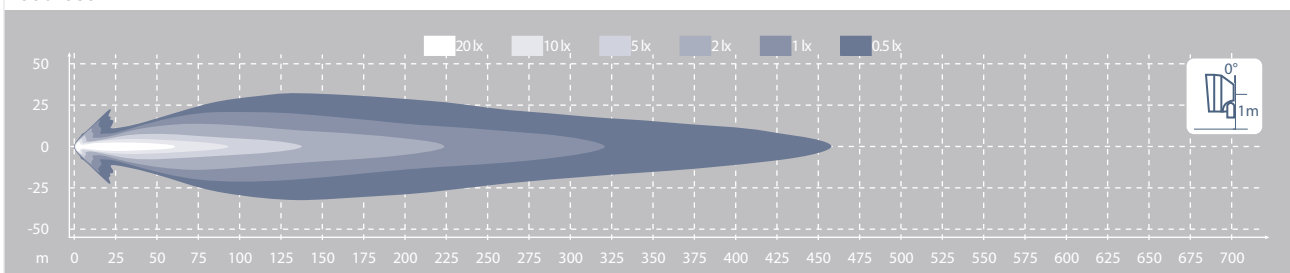

J.W. SPEAKER LED



J.W. Speaker LED



670 XD Worklamps **48**



892 Worklamp **50**



526 Worklamps **52**

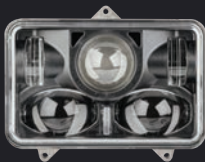

8820 Headlight **54**



8700 Evo 2 Pro Headlight **56**



793 Safety Light **58**



529 Safety Light **59**

J.W. Speaker LED

670 XD Worklamps

NEW



- Compact design.
- Multi-voltage.
- Low current draw.
- Transient spike protected.
- Environmentally sealed – IP69K.
- Impact resistant polycarbonate lens.
- TE DEUTSCH compatible connector encapsulated in body.
- 5-year warranty.
- Made in the USA.

Theoretical Lumen Output :	1,080lm
Operating Lumen Output :	780lm
Operational Voltage :	10–30V
Current Draw :	1.3A @ 12V
Connector :	DT Style – 2 Pin
Mount :	Single Bolt M8
Lens :	Polycarbonate
Body :	Polycarbonate
Weight :	0.7kg
Ingress Protection :	IP69K
Approvals :	ECE R10, UL
EMC :	CISPR12, CISPR22, SAE J1113-13
Operating Temperature :	-40°C to 65°C
Colour Temperature :	5000K
Light Source :	6 x LEDs

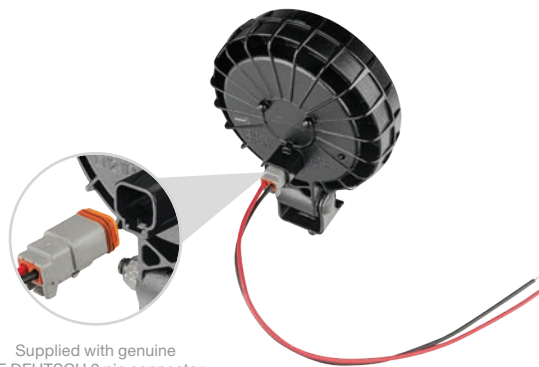

Supplied with genuine
TE DEUTSCH 2 pin connector

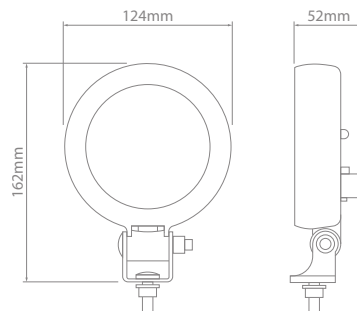

670 XD Worklamp – Flood NEW

Part No. Operational Voltage
1403241 10–30

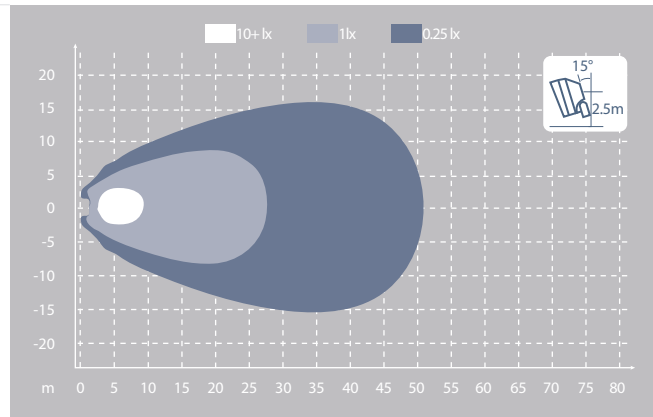

670 XD Worklamp – Trapezoid NEW

Part No. Operational Voltage
1403251 10–30

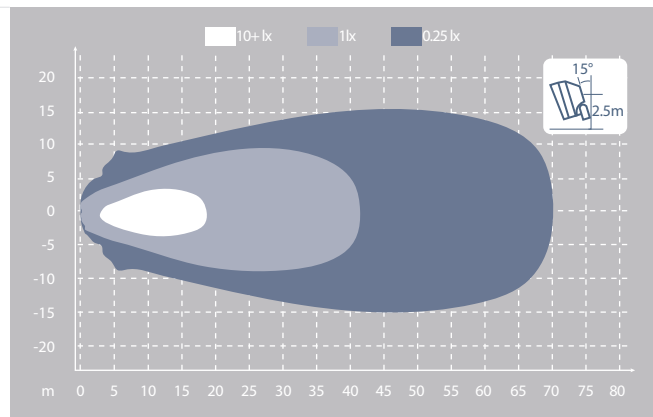

J.W. Speaker LED

892 Worklamp

NEW



- Multi-voltage.
- Low current draw.
- Environmentally sealed – IP67, IP69K.
- Impact resistant polycarbonate lens.
- Robust cast alloy body.
- Fully encapsulated internals for moisture, vibration and corrosion protection.
- TE DEUTSCH compatible connector encapsulated in body.
- Breather filter protects against water and dust ingress.
- Transient spike protected.
- 5-year warranty.
- Made in the USA.

9V 30V IP67 IP69K 5Yrs USA

Theoretical Lumen Output :	6,372lm
Operating Lumen Output :	3,800lm
Operational Voltage :	9–30V
Current Draw :	4.4A @ 12V
Connector :	DT Style – 2 Pin
Mount :	Single Bolt M8
Lens :	Polycarbonate
Body :	Aluminium
Weight :	0.4kg
Ingress Protection :	IP67, IP69K
Approvals:	ECE R10
Operating Temperature :	-40°C to 60°C
Colour Temperature :	5050K
Light Source :	18 x LEDs

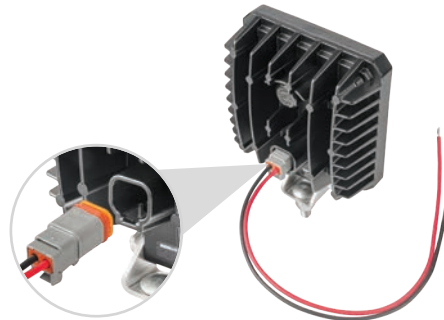

Supplied with genuine TE DEUTSCH 2 pin connector

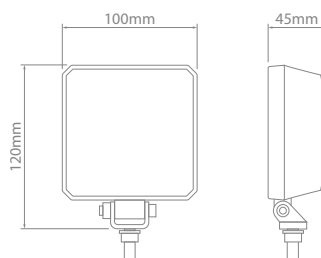

892 Worklamp – Flood NEW

Part No.
1603961

Operational Voltage
9–30

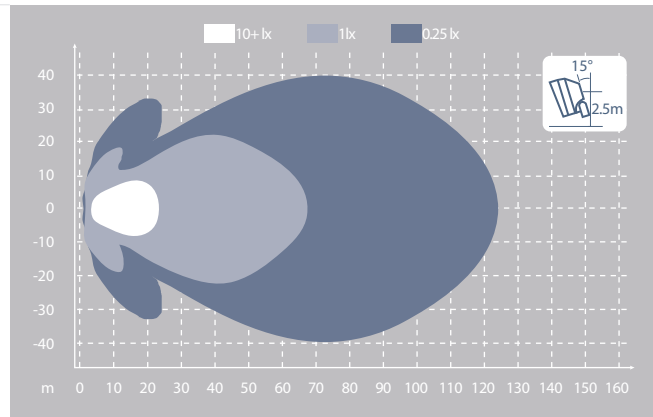

J.W. Speaker LED

NEW

526 Worklamps



- Environmentally sealed – IP69K.
- Impact resistant polycarbonate lens.
- Robust cast alloy body.
- iCONN connector encapsulated in body.
- Transient spike protected.
- 5-year warranty.
- Made in the USA.

Theoretical Lumen Output :	9,000lm
Operating Lumen Output :	5,800lm
Operational Voltage :	16–32V
Current Draw :	5A @ 24V
Connector :	iCONN iMATE23 – 2 Pin
Mount :	Single Bolt M10
Lens :	Polycarbonate
Body :	Aluminium
Weight :	2.1kg
Ingress Protection :	IP69K
Operating Temperature :	-40°C to 65°C
Colour Temperature :	5700K
Light Source :	15 x LEDs



Supplied with mating
iCONN iMATE23 2 pin
connector

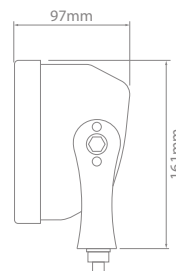
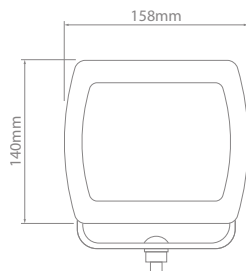

526 Worklamp – Flood NEW

Part No. **1300581** Operational Voltage **16–32**

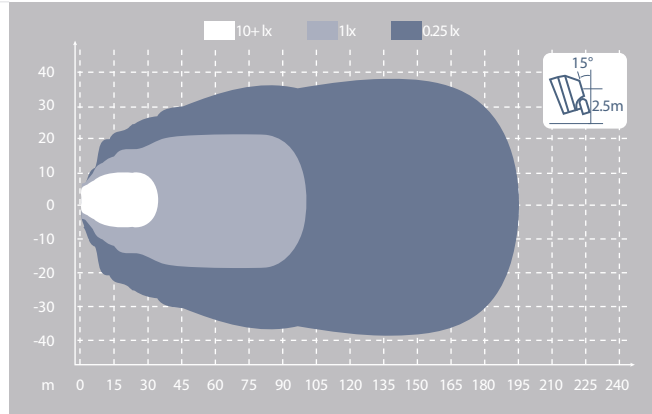

526 Worklamp – Trapezoid NEW

Part No. **1300591** Operational Voltage **16–32**

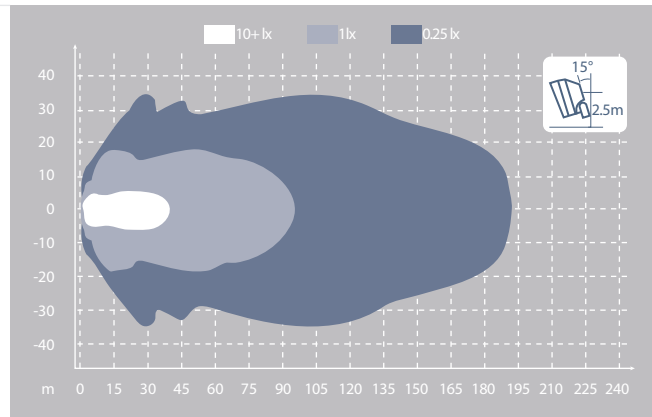

526 Worklamp – Spot NEW

Part No. **1300711** Operational Voltage **16–32**

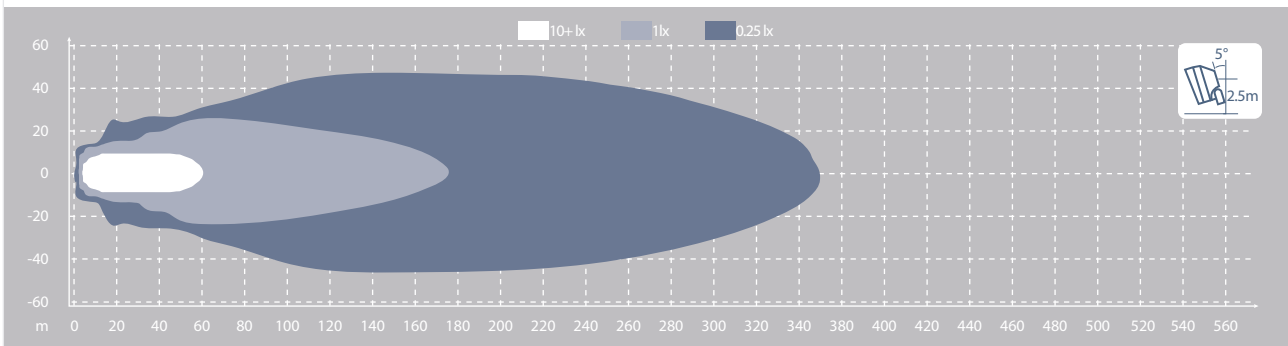

J.W. Speaker LED

NEW

8820 Headlight



- Rectangular headlight insert incorporating low beam, high beam and park light.
- Heavy duty construction.
- Complies to ADR.
- Meets military standard MIL-PRF-32243.
- Multi-voltage.
- Environmentally sealed – IP67.
- UV hard coated polycarbonate lens for high durability in harsh environments.
- Robust cast alloy body.
- Solid state LEDs provide great shock and vibration resistant.
- Breather filter protects against water and dust ingress.
- 5-year warranty.
- Made in the USA.

Theoretical Lumen Output :	Low Beam	1,850lm
	High Beam	2,100lm
Operating Lumen Output :	Low Beam	645lm
	High Beam	755lm
Operational Voltage :		10–30V
Current Draw :	Low Beam	1.1A @ 12V
	High Beam	2.1A @ 12V
	Park Light	0.06A @ 24V
Connector :		300mm Fly Lead
Lens :		UV Hard Coated Polycarbonate
Body :		Aluminium
Weight :		1.1kg
Ingress Protection :		IP67
Approvals :		ECE R7, ECR R112
		ADR, MIL-PRF-32243
Operating Temperature :		-40°C to 65°C
Light Source :		LED

- 10V 30V
- IP67
- 5Yrs
- Mil Spec
- ADR Approved
- USA

Park light

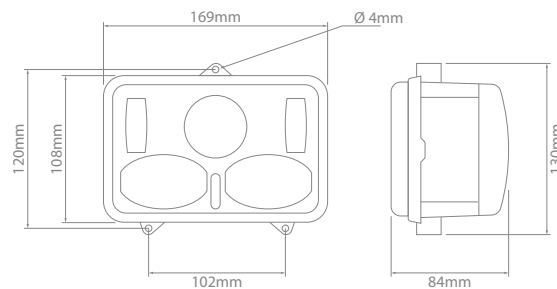
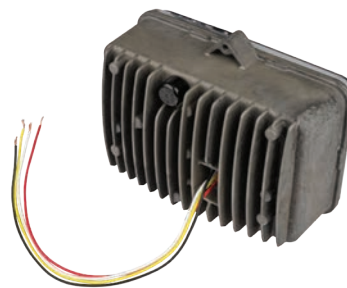

8820 Headlight – 4" x 6" NEW

Part No.

Operational Voltage

0550281

10–30

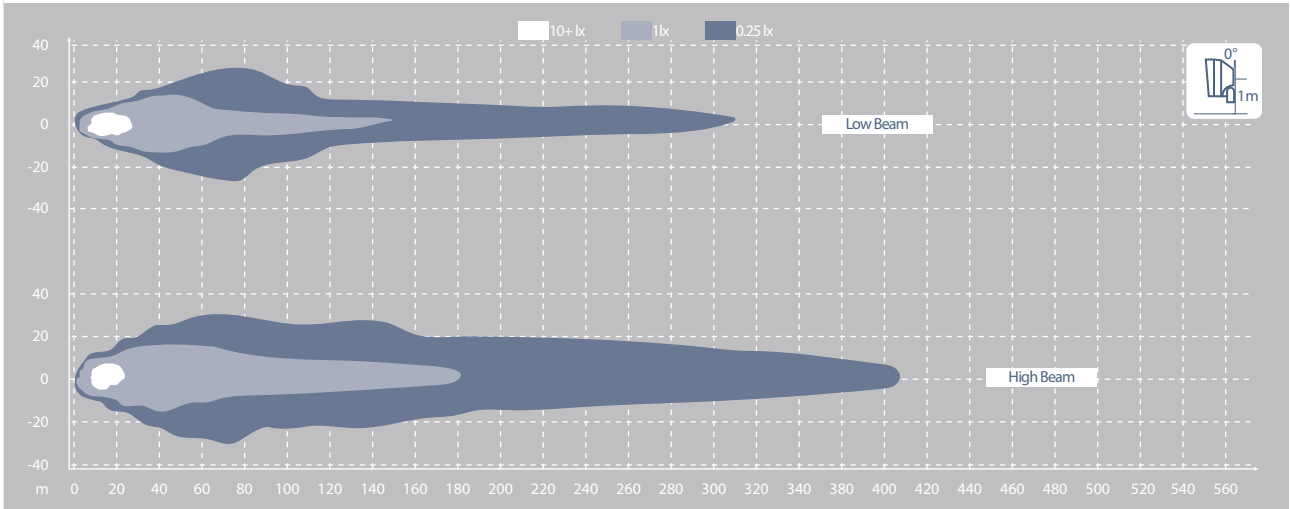

J.W. Speaker LED

8700 Evo 2 Pro Headlight

NEW



- Standard plug and play 7" round (PAR56) headlight suits wide range of vehicles.
- Integrated low beam, high beam, day time running light and park light.
- Complies to ADR.
- Dual Burn technology for brighter high beam.
- Multi-voltage.
- Environmentally sealed – IP67.
- UV hard coated polycarbonate lens for high durability in harsh environments.
- Robust cast alloy body.
- Solid state LEDs provide great shock and vibration resistance.
- Transient spike protected.
- 5-year warranty.
- Made in the USA.

Theoretical Lumen Output :	Low Beam	2,340lm
	High Beam	4,170lm
Operating Lumen Output :	Low Beam	694lm
	High Beam	1,340lm
Operational Voltage :		9–32V
Current Draw :	Low Beam	2.0A @ 12V
	High Beam	3.6A @ 12V
	Park Light	0.2A @ 12V
	Day Time Running Light	1.6A @ 12V
Spike :		150V @ 1Hz
Connector :	1 x H4, 2 x 6.3mm Blade Terminal	
Lens :	UV Hard Coated Polycarbonate	
Body :	Aluminium	
Weight :	1.0kg	
Ingress Protection :	IP67	
Approvals :	ADR, ECE R10	
Operating Temperature :	-40°C to 65°C	
Light Source :	LED	

9V 32V IP67 5Yrs ADR Approved USA



OFF



Day time running light ON

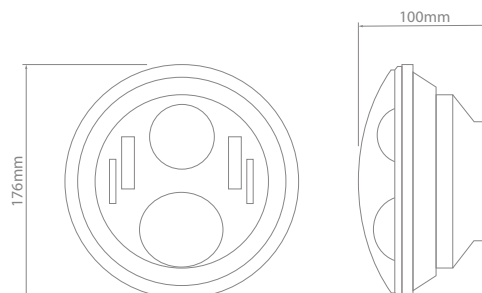

8700 Evo 2 Pro Headlight – 7" NEW

Part No.

0556951

Operational Voltage

9-32

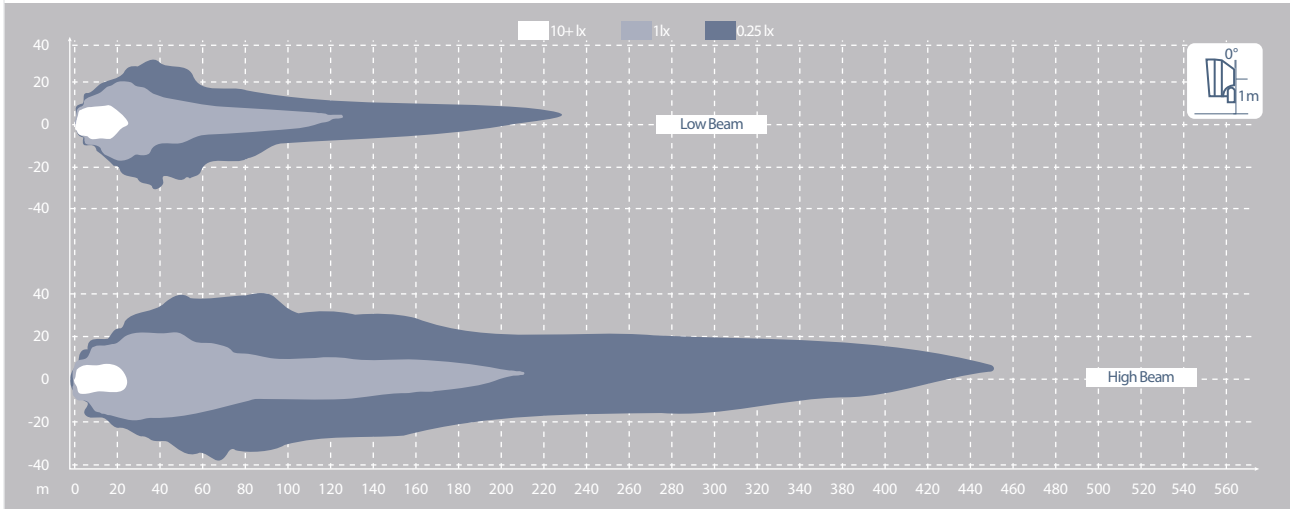

Dual Burn Technology

Dual Burn technology utilises a combination of high and low beam output when the high beam is switched on, in order to improve the intensity and precision of the light projection.

This technology results in a more focused and powerful output, increasing the effectiveness

of high beam lighting by approximately 10%, achieved through the use of precise solid optics. The result is enhanced visibility and a safer driving experience, particularly in challenging low-light and rural driving conditions.



Low Beam



Standard High Beam



Dual Burn High Beam



J.W. Speaker LED

793 Safety Light

NEW



- High power LEDs.
- Compact design.
- Extensive Multi-voltage.
- Durable polycarbonate lens.
- Robust cast alloy body.
- Stainless steel mounting bracket.
- Can be steam & pressure cleaned.
- Environmentally sealed – IP67, IP69K.
- Incorporated breather filter protects against water and dust ingress.
- 5-year warranty.
- Made in the USA.

IP67 IP69K 5Yrs USA

Connector : DT Style – 2 Pin
 Mount : Single Bolt M8
 Lens : Polycarbonate
 Body : Aluminium
 Bracket : Stainless Steel
 Weight : 0.4kg
 Ingress Protection : IP67, IP69K
 Approvals : UL, ECE R10
 Operating Temperature : -40°C to 65°C

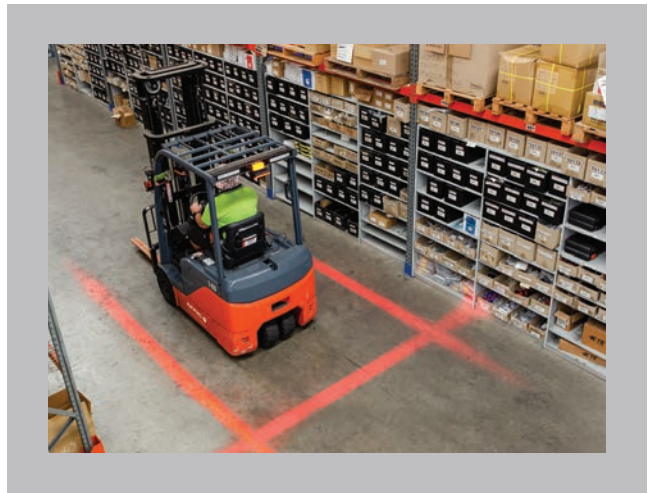
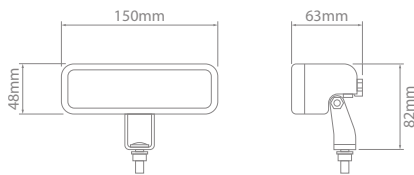

793 Safety Light **NEW**

Part No.	Operational Voltage	Colour	Current Draw
1603761	10–45	Red	1.6A @ 12V
1603871	48–110	Red	0.35A @ 48V

The projection intensity and size will vary based on the mounting height of the safety light, the diagram below provides an approximate reference.

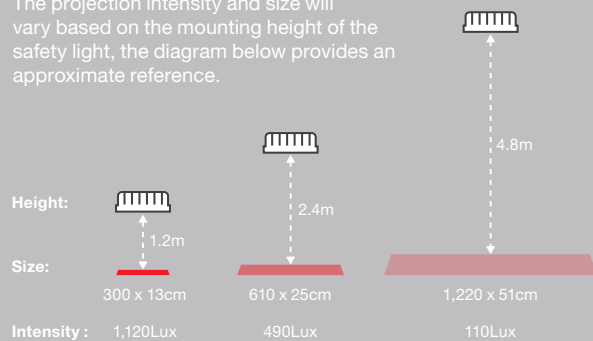

J.W. Speaker LED

NEW

529 Safety Light

- Safety light with constant & flashing mode.
- Multi-voltage.
- Durable polycarbonate lens.
- Robust cast alloy body.
- Stainless steel mounting bracket.
- Can be steam & pressure cleaned.
- Environmentally sealed – IP67, IP69K.
- Transient spike protected.
- Incorporated breather filter protects against water and dust ingress.
- 5-year warranty.
- Made in the USA.



Operational Voltage : 9–33V
 Current Draw : 3.7A @ 12V
 Connector : DT Style – 3 Pin
 Mount : 1 x M12, 2 x M8
 Lens : Polycarbonate
 Body : Aluminium
 Bracket : Stainless Steel
 Weight : 1.3kg
 Ingress Protection : IP67, IP69K
 Approvals : UL, ECE R10
 Operating Temperature : -40°C to 65°C

9V 33V IP67 IP69K 5Yrs USA



Supplied with genuine TE DEUTSCH 3 pin connector

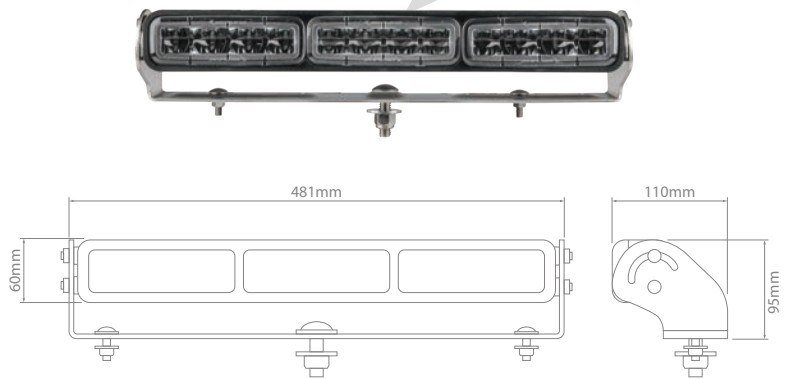

529 Safety Light NEW

Part No. 1300561 Operational Voltage 9–33 Colour Red Flash Rate per Min 60

The projection intensity and size will vary based on the mounting height of the safety light, the diagram below provides an approximate reference.

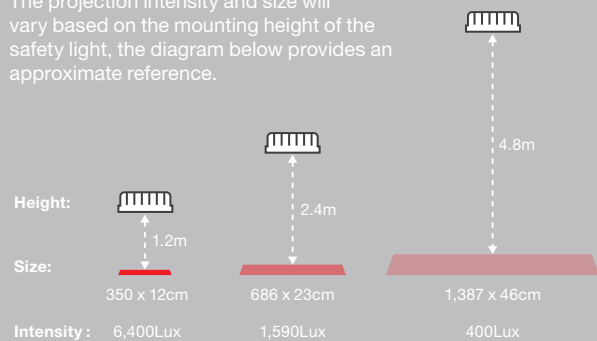

IONNICO LED Workklampen



IONNIC LED Worklamps



8210 LED 63



8220 LED 64



8230 LED 65



8095 LED 66



2100 LED 67



1090 LED 68

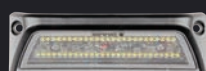

LED Scene Light 69

Introducing

ionnic | 

Series 82 Worklamps



Watch a quick video showcasing the many features of the IONNIC Series 82 Worklamps.



Watch video



IONNIC LED Worklamps

- Compact design.
- Powerful 5W LEDs.
- Stainless steel mounting bracket.
- Impact resistant lens.
- Robust cast alloy body.
- Environmentally sealed – IP67, IP6K9K.
- Model available with fly lead or TE DEUTSCH compatible connector encapsulated in body.
- Low current draw.
- Multi-voltage.
- 3-year warranty.

NEW



8210 LED

Lumen Output : 1,500lm
 Operational Voltage : 9–32V
 Current Draw : 0.7A @ 13.8V
 Mount : Single Bolt M8
 Lens : Polycarbonate
 Body : Aluminium
 Bracket : Stainless Steel
 Weight : 0.6kg
 Approvals : CE, RoHS
 Ingress Protection : IP67, IP6K9K
 Operating Temperature : -40°C to 85°C
 Colour Temperature : 5500K
 Light Source : 4 x Osram 5W LEDs

12V 32V IP67 IP69K 3Yrs

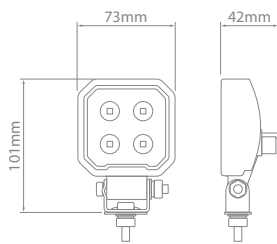

8210 LED – Flood NEW

Part No.	Operational Voltage	Connector
98-8210	9–32	DT Style – 2 Pin
98-8210L	9–32	300mm Fly Lead

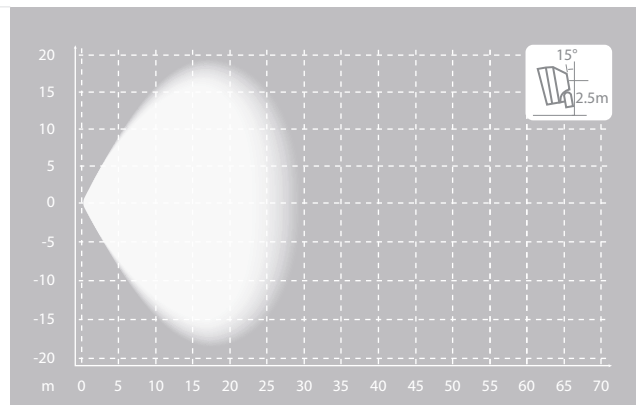

IONNIC LED Worklamps

NEW

8220 LED



- 12V
32V
- IP67
- IP69K
- 3Yrs

- Powerful 5W LEDs.
- Stainless steel mounting bracket.
- Impact resistant lens.
- Robust cast alloy body.
- Environmentally sealed – IP67, IP6K9K.
- TE DEUTSCH compatible connector encapsulated in body.
- Low current draw.
- Multi-voltage.
- 3-year warranty.

Lumen Output :	2,350lm
Operational Voltage :	9–32V
Current Draw :	1.2A @ 13.8V
Connector :	DT Style – 2 Pin
Mount :	Single Bolt M10
Lens :	Polycarbonate
Body :	Aluminium
Bracket :	Stainless Steel
Weight :	0.8kg
Approvals :	CE, RoHS
Ingress Protection :	IP67, IP6K9K
Operating Temperature :	-40°C to 85°C
Colour Temperature :	5500K
Light Source :	6 x Osram 5W LEDs



Supplied with genuine TE DEUTSCH Connector

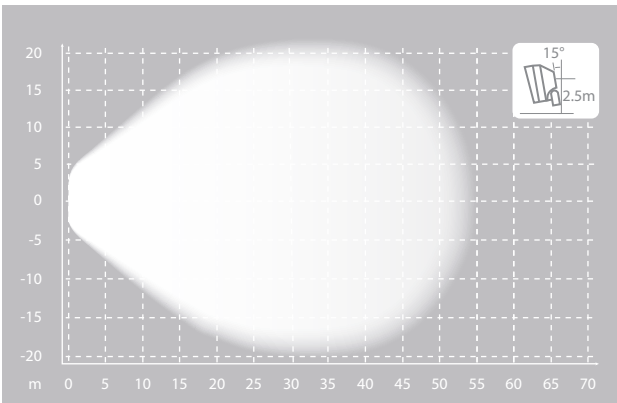
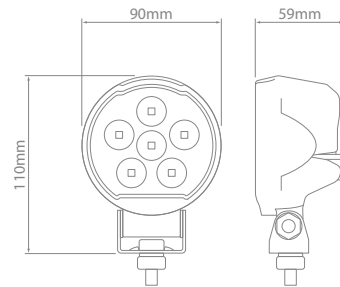

8220 LED – Flood NEW

Part No. **98-8220** Operational Voltage **9–32**

IONNIC LED Worklamps

- Powerful 5W LEDs.
- Stainless steel mounting bracket.
- Impact resistant lens.
- Robust cast alloy body.
- Environmentally sealed – IP67, IP6K9K.
- TE DEUTSCH compatible connector encapsulated in body.
- Multi-voltage.
- 3-year warranty.

NEW



8230 LED

Lumen Output :	3,500lm
Operational Voltage :	9–32V
Current Draw :	2.0A @ 13.8V
Connector :	DT Style – 2 Pin
Mount :	Single Bolt M10
Lens :	Polycarbonate
Body :	Aluminium
Bracket :	Stainless Steel
Weight :	1.0kg
Approvals :	CE, RoHS
Ingress Protection :	IP67, IP6K9K
Operating Temperature :	-40°C to 85°C
Colour Temperature :	5500K
Light Source :	9 x Osram 5W LEDs

- 12V 32V
- IP67
- IP69K
- 3Yrs

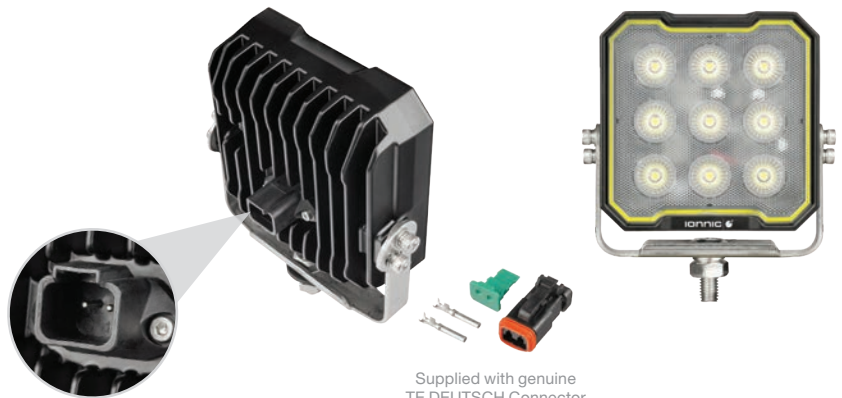
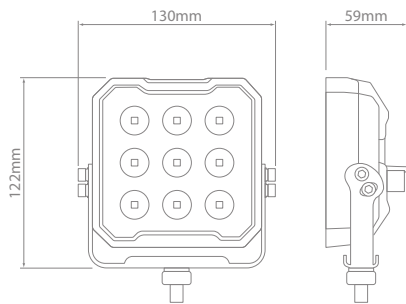

Supplied with genuine TE DEUTSCH Connector

8230 LED – Flood NEW

Part No. **98-8230** Operational Voltage **9–32**

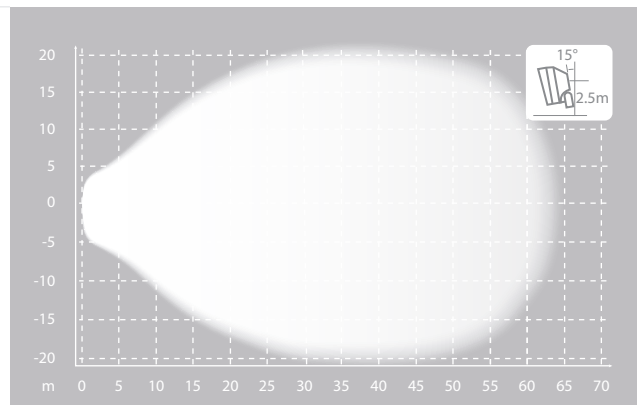

IONNIC LED Worklamps

8095 LED



- 9V
32V
- IP67
- IP69K
- 3Yrs

- Cost effective, high quality worklamp.
- Compact design.
- Swivel bracket for easy on-site adjustment.
- Removable, anti-slip rubber wrapped handle.
- Integrated toggle switch with sealing boot.
- Multi-voltage.
- Even light pattern without hotspots.
- Impact resistant lens.
- Environmentally sealed – IP67, IP69K.
- 3-year warranty.

Theoretical Lumen Output :	950lm
Operating Lumen Output :	600lm
Operational Voltage :	9–32V
Current Draw :	0.6A @ 13.8V
Max Power Consumption :	9W
LED Lifetime :	30,000 Hrs
Connector :	AMP 2 Pin
Mount :	4 x M6 Bolt
Lens :	Polycarbonate
Body :	Aluminium
Bracket :	Stainless Steel
Weight :	0.95kg
Approvals :	CE, ECE R10
Ingress Protection :	IP67, IP69K
Operating Temperature :	-20°C to 50°C
Colour Temperature :	6000K
Light Source :	5 x Osram 3W LEDs

360°



Toggle switch with sealing boot



Supplied with matching AMP connector on fly lead

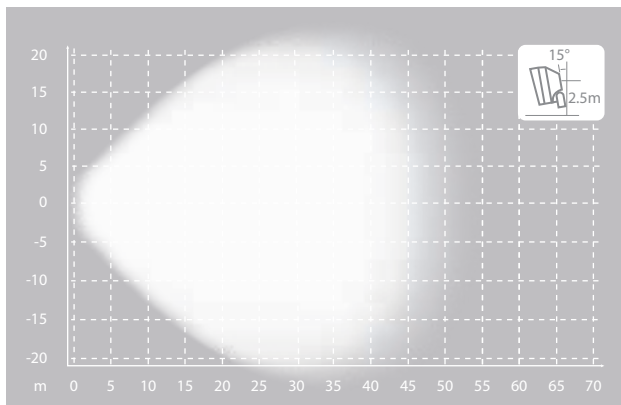
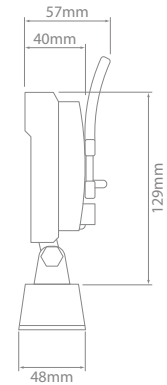
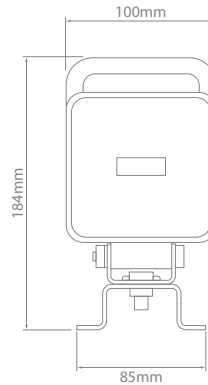

8095 LED – Flood

Part No.
98-8095

Operational Voltage
9–32

IONNIC LED Worklamps

2100 LED

- Handle & spring tensioned bracket for easy on-site adjustment.
- Integrated rocker switch with sealing boot.
- Multi-voltage.
- Long life LEDs.
- Low current draw.
- Even light pattern without hotspots.
- Impact resistant lens.
- Environmentally sealed – IP67.
- 3-year warranty.

Lumen Output :	1,490lm
Operational Voltage :	12–36V
Current Draw :	1.4A @ 13V
Max Power Consumption :	22W
LED Lifetime :	30,000 Hrs
Connector :	DT Style – 2 Pin
Cable Length :	280mm
Mount :	<i>user supplied</i> 4 x M8 Bolt
Lens :	Polycarbonate
Body :	Aluminium
Bracket :	Stainless Steel
Weight :	0.6kg
Ingress Protection :	IP67
Operating Temperature :	-30°C to 50°C
Colour Temperature :	6500K
Light Source :	9 x SMD High Power LEDs



12V 36V IP67 3Yrs

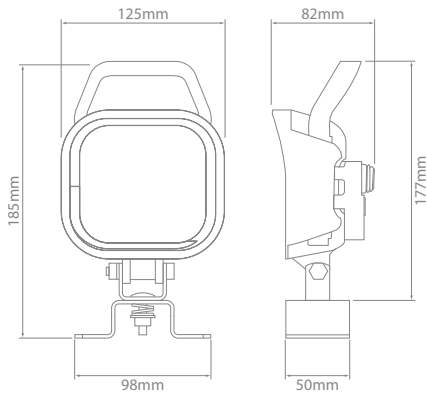

2100 LED – Flood

Part No.	Operational Voltage
98-2100	12–36

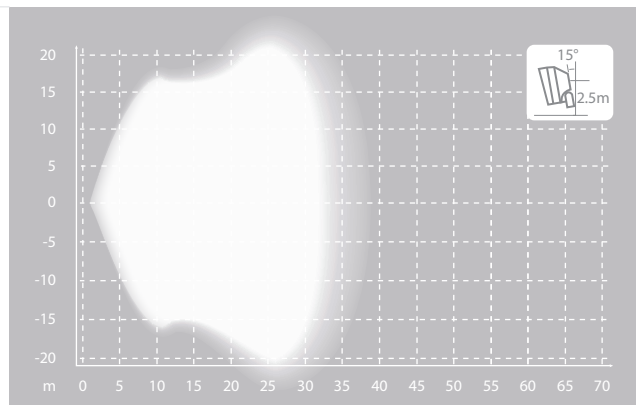

IONNIC LED Worklamps

1090 LED



12V
36V

IP67

5Yrs

- Extremely compact & lightweight.
- Low current draw.
- Even light pattern without hotspots.
- Impact resistant lens.
- Epoxy encapsulated electronics.
- Multi-voltage.
- Environmentally sealed – IP67.
- Aluminium body.
- 5-year warranty.

Lumen Output :	600lm
Operational Voltage :	12–36V
Current Draw :	0.68A @ 13.5V
Max Power Consumption :	9W
LED Lifetime :	50,000 Hrs
Connector :	280mm Fly Lead
Mount :	Single Bolt M8
Lens :	Polycarbonate
Body :	Aluminium
Bracket :	Stainless Steel
Weight :	0.17kg
Ingress Protection :	IP67
Operating Temperature :	-30°C to 50°C
Colour Temperature :	5000K
Light Source :	3 x Edison® 3W LEDs

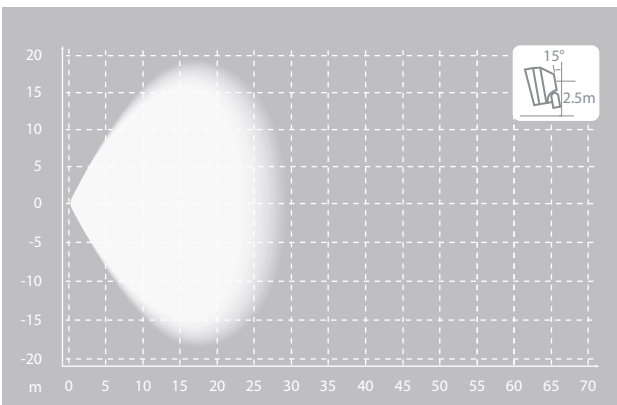
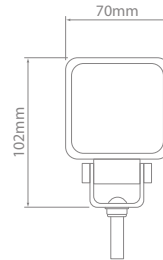

1090 LED – Flood

Part No.	Operational Voltage
98-1090	12–36
98-1090BK*	12–36

*Bulk pack of 10 worklamps.

IONNIC LED Worklamps

LED Scene Light

- Ideal for interior or exterior applications.
- Compact & lightweight.
- Multi-voltage.
- Long life LEDs.
- Low current draw.
- Impact resistant lens.
- Environmentally sealed – IP67, IP69K.
- Robust cast alloy body.
- 3-year warranty.



Theoretical Lumen Output :	6,500lm
Operational Lumen Output :	2,296lm
Operational Voltage :	9–35V
Current Draw :	1.4A @ 13.8V
LED Lifetime :	30,000 Hrs
Connector :	500mm Fly Lead
Mount :	2 x #10 Screw
Lens :	Polycarbonate
Body :	Aluminium
Weight :	0.25kg
Ingress Protection :	IP67, IP69K
Approvals :	CE, ECE R10
Operating Temperature :	-20°C to 45°C
Colour Temperature :	6000K
Light Source :	52 x Osram 0.3W LEDs

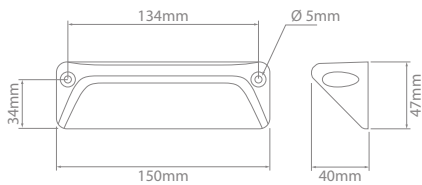

LED Scene Light

Part No. Operational Voltage
98-9244 **9–35**

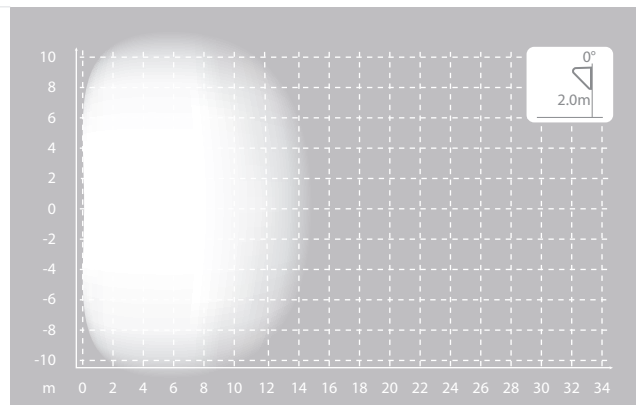

IONNIC LED Driving Lights



IONNIC LED Driving Lights



Night Ranger 7" 74



Night Ranger 9" 76



Night Ranger SR 78

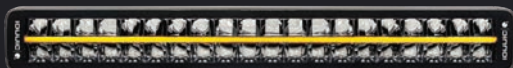

Night Ranger DR 80



NUUK LED 82

Introducing

ionnic | 

Night Ranger
Driving Lights



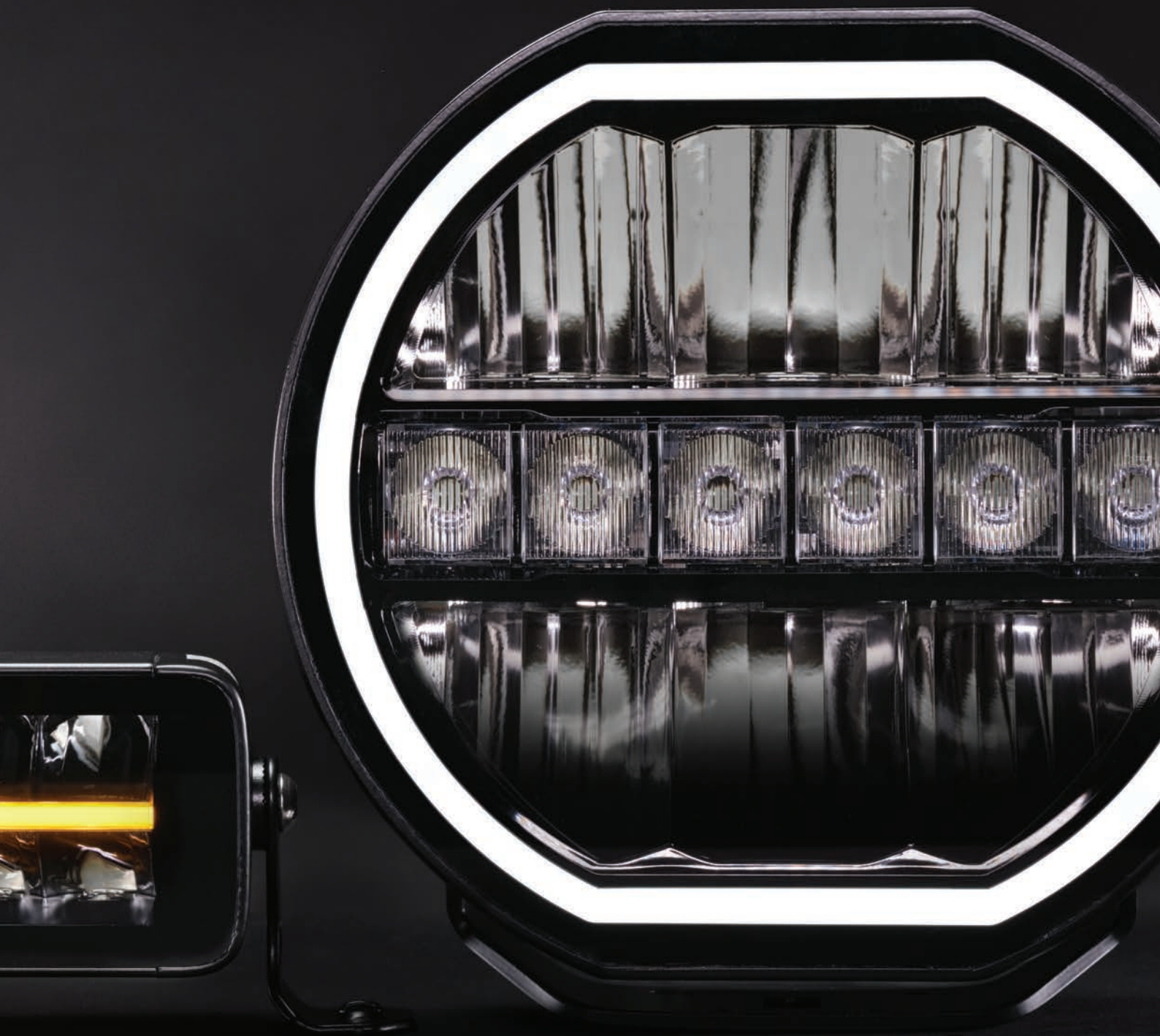

IONNIC LED Driving Lights

Night Ranger 7"

NEW



- 9V
32V
- IP68
- IP69K
- 3Yrs

- Latest high output LED technology.
- LED position lights can be switched to white or amber.
- Stainless steel mounting brackets.
- Impact resistant lens.
- Environmentally sealed aluminium body – IP68, IP69K.
- Multi-voltage.
- 3-year warranty.

Operational Voltage :	9–32V
Max. Power Consumption :	108W
Lens :	Polycarbonate
Body :	Aluminium
Bracket :	Stainless Steel
Mount :	Single Bolt M10
Weight :	1.7kg
Cable Length :	500mm
Light Source :	18 x CREE 6W LEDs
LED Colour Temperature :	6000K
Operating Temperature :	-20°C to 45°C
Ingress Protection :	IP68, IP69K
Approvals :	ECE R10, ECE R148, R149 CE, RoHS, CISPR25 CLASS3



LED position light can be switched to white or amber

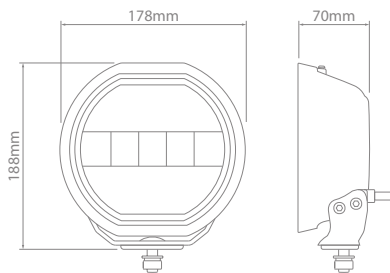
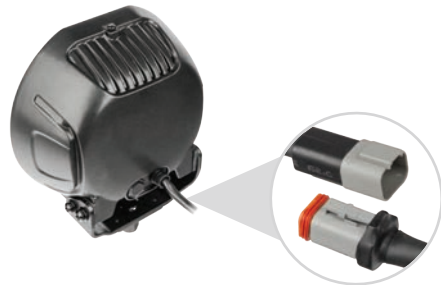

IONNIC LED Driving Lights

Night Ranger 7" – Driving Light NEW

Part No.	Operational Voltage	Lumen Output		Current Draw (A) @ 13.8V		
		Theoretical	Operational	High Beam	White Position	Amber Position
98-9197	9-32	9,600	6,467	4.9	0.8	1.1

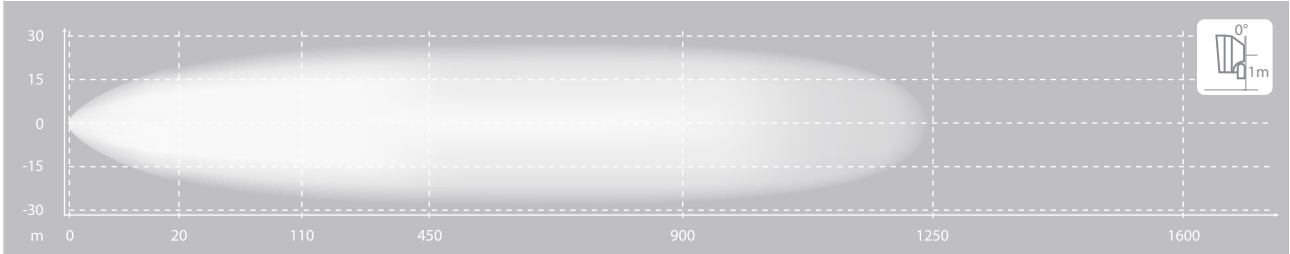

IONNIC LED Driving Lights

Night Ranger 9"

NEW



- 9V
32V
- IP68
- IP69K
- 3Yrs

- Ultimate illumination – 20,400lm.
- Latest high output LED technology.
- LED position light can be switched to white or amber.
- Stainless steel mounting brackets.
- Impact resistant lens.
- Environmentally sealed aluminium body – IP68, IP69K.
- Multi-voltage.
- 3-year warranty.

Operational Voltage :	9–32V
Max. Power Consumption :	144W
Lens :	Polycarbonate
Body :	Aluminium
Bracket :	Stainless Steel
Mount :	Single Bolt M12
Weight :	2.5kg
Cable Length :	500mm
Light Source :	24 x CREE 6W LEDs
LED Colour Temperature :	6000K
Operating Temperature :	-20°C to 45°C
Ingress Protection :	IP68, IP69K
Approvals :	ECE R10, ECE R148, R149 CE, RoHS, CISPR25 CLASS3



LED position light can be switched to white or amber

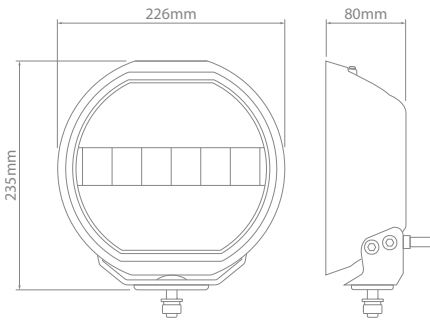

IONNIC LED Driving Lights

Night Ranger 9" – Driving Light NEW

Part No.	Operational Voltage	Lumen Output		Current Draw (A) @ 13.8V		
		Theoretical	Operational	High Beam	White Position	Amber Position
98-9199	9-32	20,400	13,377	8.1	1.1	1.1

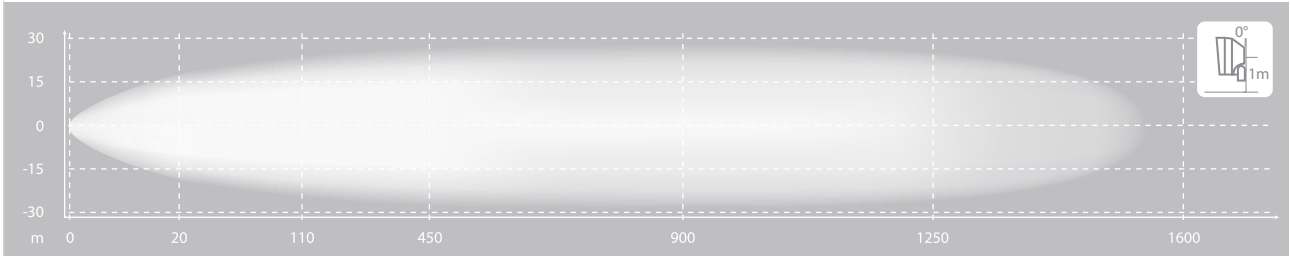

IONNIC LED Driving Lights

Night Ranger SR

NEW



- Latest high output LED technology.
- LED position lights can be switched to white or amber.
- Supplied with side & rear stainless steel mounting brackets.
- Mounting channel runs entire length of bar allowing flexible mounting options.
- Impact resistant lens.
- Environmentally sealed aluminium body – IP68, IP69K.
- Multi-voltage.
- 3-year warranty.

10V 30V IP68 IP69K 3Yrs

Operational Voltage :	10–30V
Max. Power Consumption :	95W
Lens :	Polycarbonate
Body :	Aluminium
Bracket :	Stainless Steel
Mount :	2 x M8 Bolt
Weight :	1.5kg
Cable Length :	500mm
Light Source :	21 x Osram 5W LEDs
LED Colour Temperature :	5700K
Operating Temperature :	-20°C to 45°C
Ingress Protection :	IP68, IP69K
Approvals :	CE, RoHS, ECE R10, ECE R148, R149

Supplied with side & rear mounting brackets

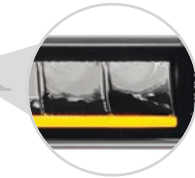

LED position light can be switched to white or amber

Mounting channel runs entire length of bar allowing flexible mounting options

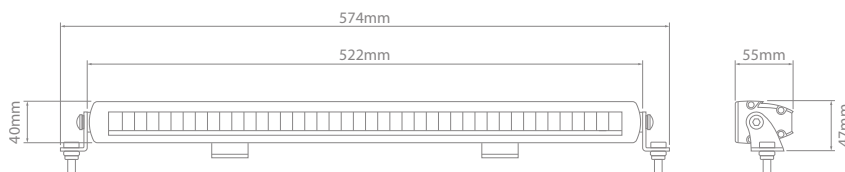

IONNIC LED Driving Lights

Night Ranger SR – Single Row NEW

Part No.	Operational Voltage	Lumen Output		Current Draw (A) @ 13.8V		
		Theoretical	Operational	High Beam	White Position	Amber Position
98-9171	10-30	8,820	6,332	6.2	0.5	0.5

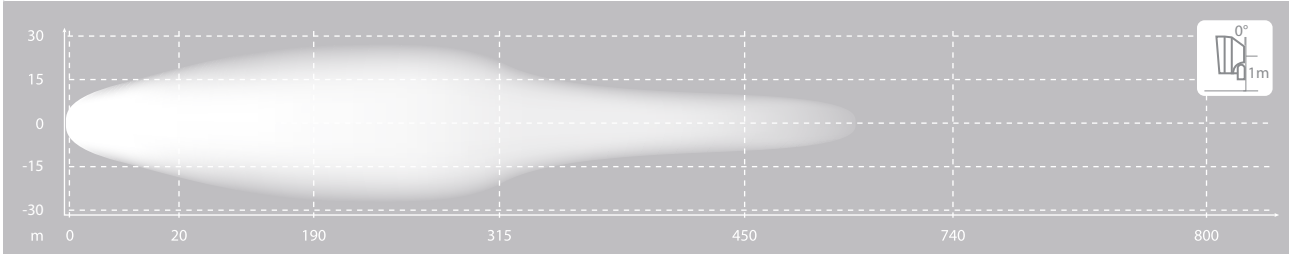

IONNIC LED Driving Lights

Night Ranger DR

NEW

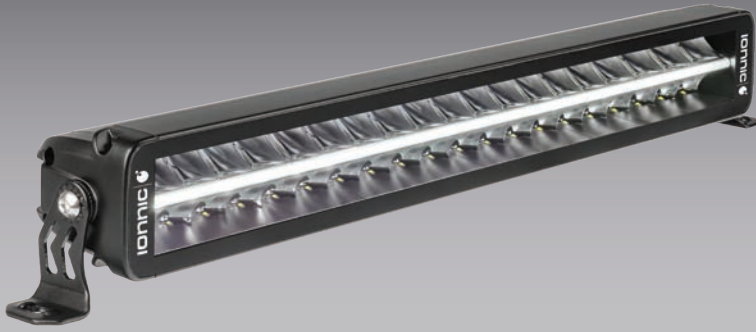

- Ultimate illumination – 16,800lm.
- Latest high output LED technology.
- LED position lights can be switched to white or amber.
- Supplied with side & rear stainless steel mounting brackets.
- Mounting channel runs entire length of bar allowing flexible mounting options.
- Impact resistant lens.
- Environmentally sealed aluminium body – IP68, IP69K.
- Multi-voltage.
- 3-year warranty.

10V
30V IP68 IP69K 3Yrs

Operational Voltage :	10–30V
Max. Power Consumption :	214W
Lens :	Polycarbonate
Body :	Aluminium
Bracket :	Stainless Steel
Mount :	2 x M8 Bolt
Weight :	2.5kg
Cable Length :	500mm
Light Source :	40 x Osram 5W LEDs
LED Colour Temperature :	5700K
Operating Temperature :	-20°C to 45°C
Ingress Protection :	IP68, IP69K
Approvals :	CE, RoHS, ECE R10, ECE R148, R149



Supplied with side & rear mounting brackets

Mounting channel runs entire length of bar allowing flexible mounting options

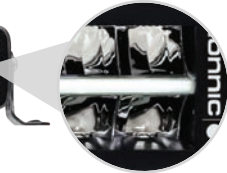

LED position light can be switched to white or amber

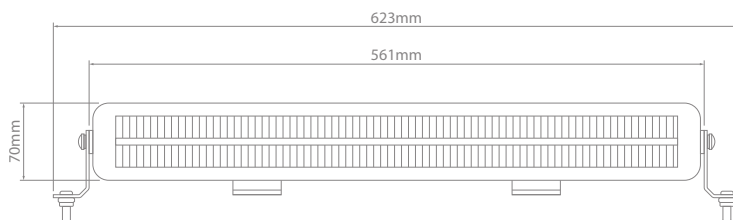

IONNIC

IONNIC LED Driving Lights

Night Ranger DR – Double Row NEW

Part No.	Operational Voltage	Lumen Output		Current Draw (A) @ 13.8V		
		Theoretical	Operational	High Beam	White Position	Amber Position
98-9181	10-30	16,800	10,246	11.5	0.6	0.6

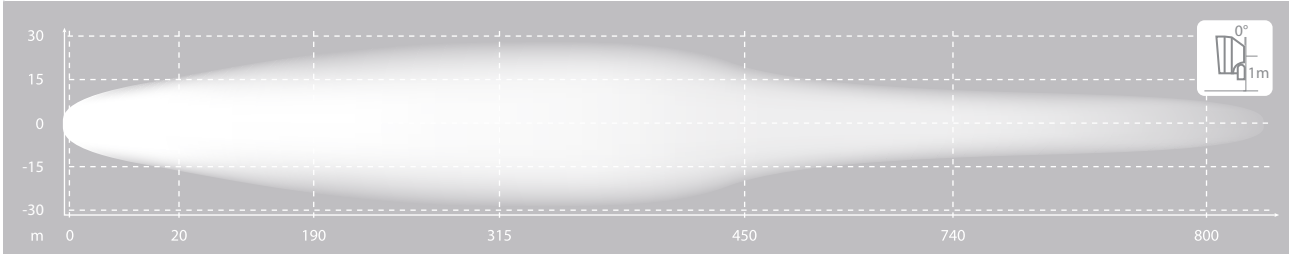

IONNIC LED Driving Lights

NUUK LED

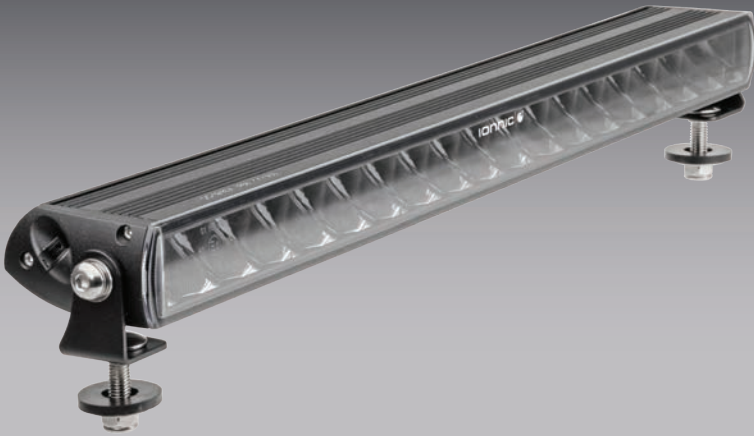

- Sleek and stylish design.
- Exceptional light output.
- Adjustable heavy duty mounting brackets – sides and rear.
- Low profile.
- Even light pattern without hotspots.
- Impact resistant polycarbonate lens.
- Environmentally sealed aluminium body – IP68.
- Multi-voltage.
- 3-year warranty.

Voltage :	12–30V
Max Power Consumption :	90W
Current Draw :	5.5A @ 13.8V
Lens :	Polycarbonate
Body :	Aluminium
Mount :	2 x M8 Bolt
Weight :	1.4kg
Connector :	DT Style – 2 Pin
Cable Length :	500mm
Ingress Protection :	IP68
Light Source :	18 x LG InNotek LEDs
LED Colour Temperature :	6500K
Operating Temperature :	-40°C to 60°C
Approvals :	ECE R10, R112



Mounting channel runs entire length of bar allowing flexible mounting options

Supplied with both rear and side mounting brackets

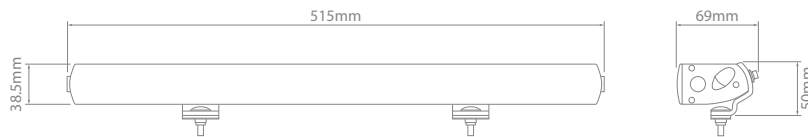

NUUK LED

Part No.	Operational Voltage	Lumen Output		Current Draw (A) @ 13.8V	Weight (kg)
		Theoretical	Operational		
98-9114	12–30	8,100	6,950	5.5	1.4

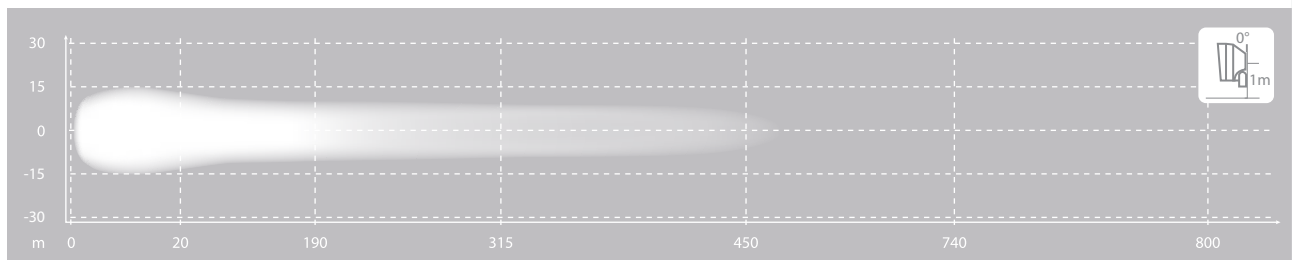

Lighting Accessories

Bull Bar Mounting Brackets

- Ideal for fitment to bull bars, sports bars etc.
- Available in 3 sizes – 2", 2.5" & 3".
- Heavy duty powder coated aluminium construction.
- Silicone gasket prevents damage to bar.
- Stainless steel hardware.
- Easy mounting solution for accessories including:
 - Worklamps
 - Lightbars
 - Beacons
 - Antennas

BBM-20



BBM-30

Material : Aluminium Alloy
 Gasket : Silicone
 Hardware : Stainless Steel
 Mounting Hole : 10mm

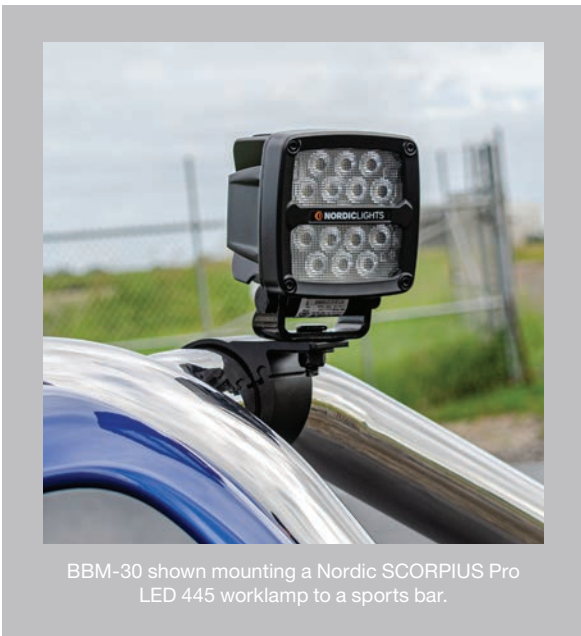

BBM-30 shown mounting a Nordic SCORPIUS Pro LED 445 worklamp to a sports bar.

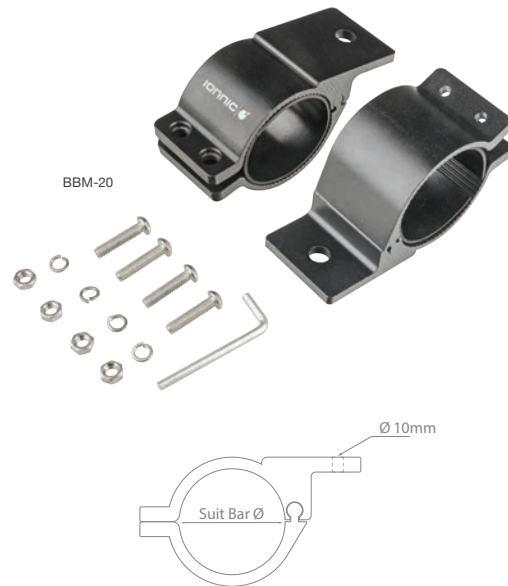

Lighting Accessories – Bull Bar Mounting Brackets NEW

Part No.	Suit Bar Ø		Pack Qty
	Inches	mm	
BBM-20	2.0	50	2
BBM-25	2.5	64	2
BBM-30	3.0	76	2

Including bolts, nuts, split washers and a hex key.



LED Interior Lighting



LED Interior Lighting

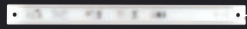

LED Strip Light **86**

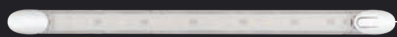

LED Strip Lights with Switch **88**



Dome Light - Round **90**

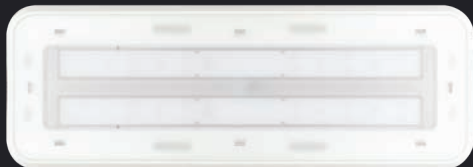

Dome Light - Rectangular **91**

LED Interior Lighting

LED Strip Light



- High output LEDs.
- Low current draw.
- Multi-voltage.
- Easy installation.
- Slimline design.
- Polycarbonate construction.
- Frosted lens for diffused light.
- Optional mounting brackets available.
- 5-year warranty.

10V
30V 5Yrs

Operational Voltage :	10–30V
Lens :	Polycarbonate
Body :	Polycarbonate
Weight :	0.05kg
Connector :	250mm Fly Lead
Light Source :	6 x LEDs
Operating Temperature :	-20°C to 60°C

Ultra Wide 180° Light Dispersion

Compact and easy to install the LED Strip Light produces a remarkable 180° of even, diffused light, to comfortably illuminate large vehicle interiors and compartments.

Ideal for commercial vehicles, canopies, service bodies, lockers, marine applications and more.

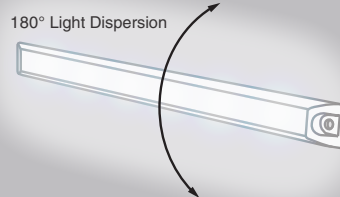

Example of one Strip Light installed illuminating an entire canopy.

LED Interior Lighting

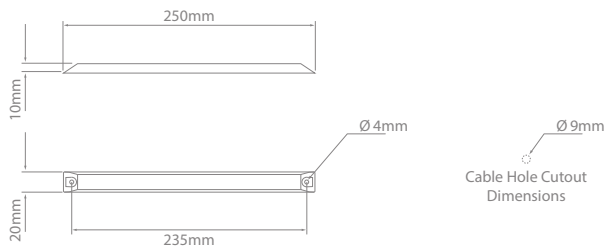

LED Strip Light

Part No.	Operational Voltage	No. of LEDs	Lumen	Current Draw (A) @ 12V
INT250	10–30	6	420	0.4

Not recommended for mounting on synthetic surfaces.

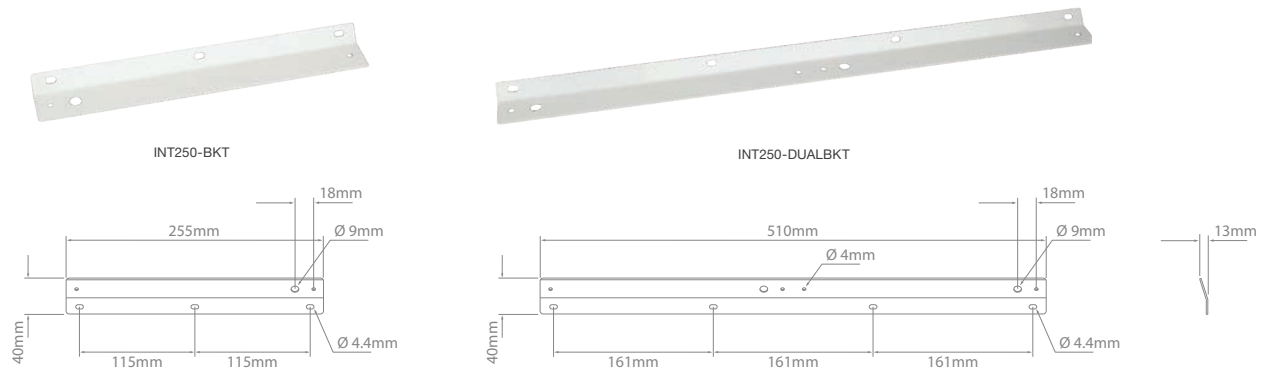

LED Strip Light – Mounting Brackets

Part No.	Description
INT250-BKT	Powder coated steel, suits 1 x INT250
INT250-DUALBKT	Powder coated steel, suits 2 x INT250



LED Interior Lighting

LED Strip Lights with Switch

12V
24V

5Yrs

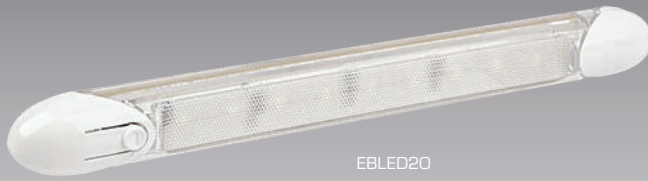

- Incorporated latching push button ON/OFF switch.
- High output LEDs.
- Low current draw.
- Multi-voltage.
- Easy installation.
- Slimline design.
- Polycarbonate construction.
- Epoxy sealed for vibration & moisture resistance.
- 5-year warranty.

Operational Voltage : 12-24V
 Lens : Polycarbonate
 Body : Polycarbonate
 Connector : 100mm Fly Lead
 Light Source : LED
 Operating Temperature : -30°C to 50°C

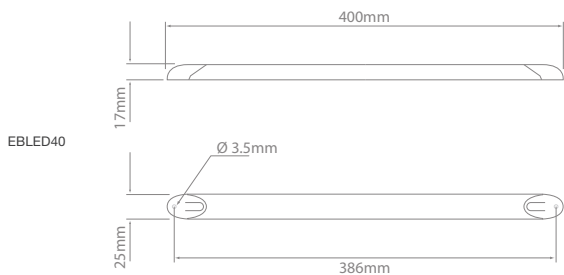
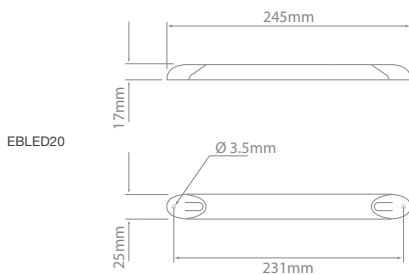

LED Strip Lights with Switch

Part No.	Operational Voltage	No. of LEDs	Lumen	Current Draw (A) @ 12V	Weight (kg)
EBLED20	12-24	9	110	0.2	0.05
EBLED40	12-24	18	220	0.4	0.09

ionnic.com



Visit website

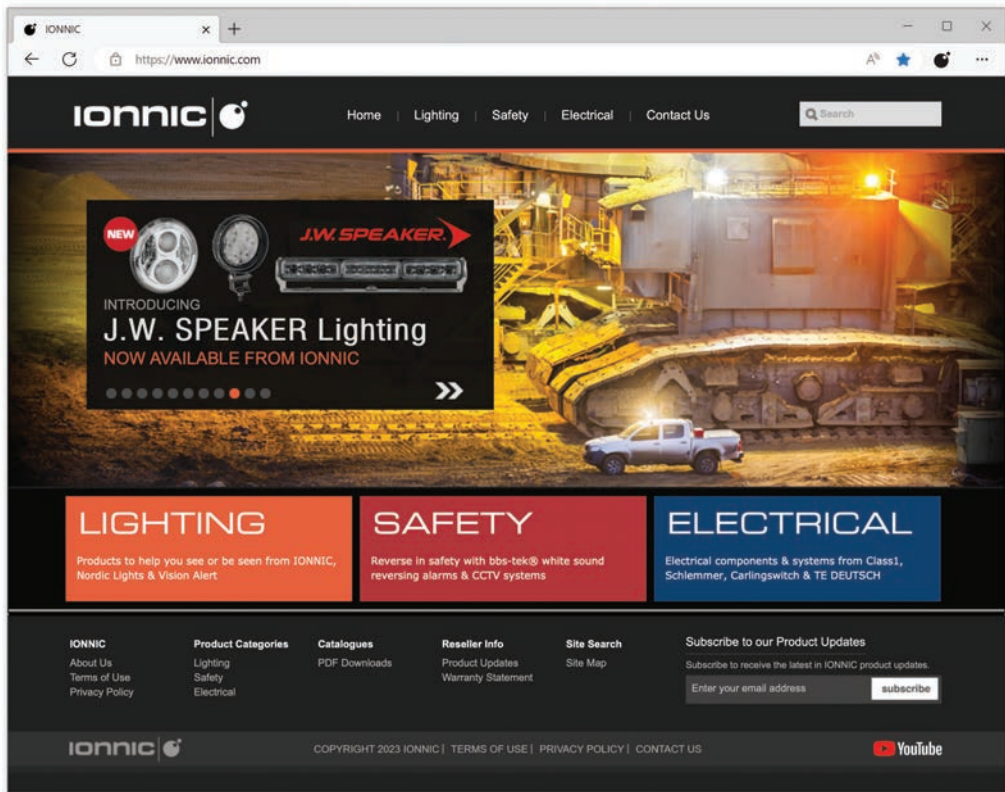

Check out the entire range of Worklamps

The IONNIC website – for all the most up to date products and info

LED Interior Lighting

Dome Light – Round

NEW



- Meets GSA-KKK and NFPA 1917 standards for illumination, when installed according to manufacturer's specifications.
- Ultra slim design, protrudes less than 4.8mm.
- Each unit colour temperature checked to 4100K for accurate skin tone rendering.
- Robust cast alloy body.
- Even, consistent & wide angle 1,000 lumen output.
- Output can be adjustable with PWM (Pulse Width Modulation) dimmer.
- Integrated cooling fins.
- Made in North America.
- 5-year warranty.

5Yrs **Made in North America**

Operational Voltage : 10–16V
 Lens : Acrylic
 Body : Aluminium
 Weight : 0.6kg
 Connector : 300mm Fly Lead
 Operating Temperature : -40°C to 65°C
 Colour Temperature : 4100K
 Approvals : UL, GSA-KKK, NFPA 1964

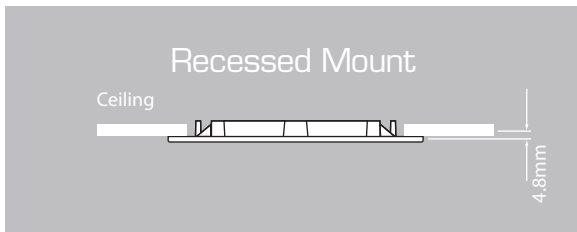
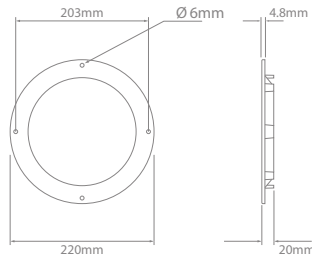

GSA-KKK & NFPA 1917 Compliant

Meets GSA-KKK and NFPA 1917 standards for illumination, when installed according to manufacturer's specifications.



Dome Light – Round – Recessed Mount **NEW**

Part No.	Operational Voltage	No. of LEDs	Lumen	Current Draw (A)	
				Low Output	High Output
8052-0000-30	10–16	21	1,000	0.6	1.2

- Extreme light output – 2,300 Lumen.
- Multi-voltage.
- Easy installation.
- Slimline design
- Polycarbonate lens.
- Frosted lens for diffused light.
- Environmentally sealed – IP67.
- Epoxy sealed for vibration & moisture resistance.
- 5-year warranty.

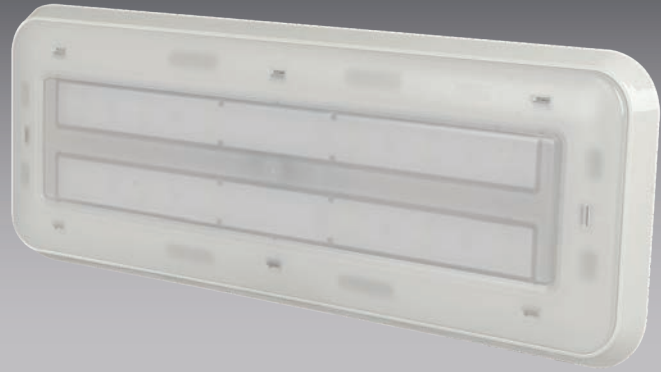

Operational Voltage : 10–30V
 Lens : Polycarbonate
 Body : Polycarbonate
 Weight : 0.95kg
 Connector : 460mm Fly Lead
 Ingress Protection : IP67
 Operating Temperature : -30°C to 50°C
 Colour Temperature : 6000K
 Approvals : CE

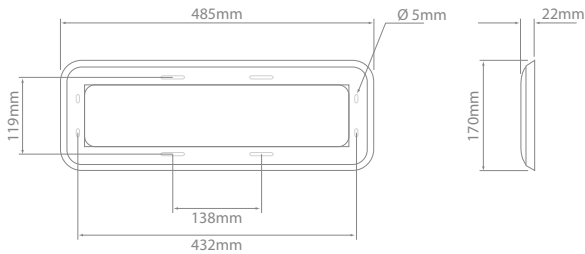

Dome Light – Rectangular – Surface Mount

Part No.	Operational Voltage	No. of LEDs	Lumen	Current Draw (A)
ECLED30	10–30	12	2,300	2.2



Index

Part No.	Page	Part No.	Page
0		988-101	35
0550281	55	988-102	35
0556951	57	988-203	39
1		988-204	39
1300561	59	98-8210	63
1300581	53	98-8210L	63
1300591	53	98-8220	64
1300711	53	98-8230	65
1403241	49	988-297	39
1403251	49	988-408	33
1603761	58	98-9114	82
1603871	58	98-9171	79
1603961	51	98-9181	81
8		98-9197	75
8052-0000-30	90	98-9199	77
9		98-9244	69
960-005	29	990-038	45
960-006	29	990-039	45
980-101	15	990-040	45
98-1090	68	990-054	45
98-1090BK	68	990-058	45
981-202	11	990-059	45
981-301	13	B	
981-302	13	BBM-20	83
981-303	13	BBM-25	83
981-311	13	BBM-30	83
981-318	13	E	
981-319	13	EBLED20	88
981-320	13	EBLED40	88
98-2100	67	ECLED30	91
982-608	37	I	
982-609	37	INT250	87
982-803	41	INT250-BKT	87
982-804	41	INT250-DUALBKT	87
984-036	17		
984-037	17		
984-038	17		
984-039	17		
984-101	19		
984-102	19		
984-103	19		
984-104	19		
984-401	25		
984-402	25		
984-701	21		
984-702	21		
984-703	21		
984-704	21		
986-101	23		
986-102	23		
986-103	23		
986-104	23		
987-101	27		
987-102	27		
98-8095	66		

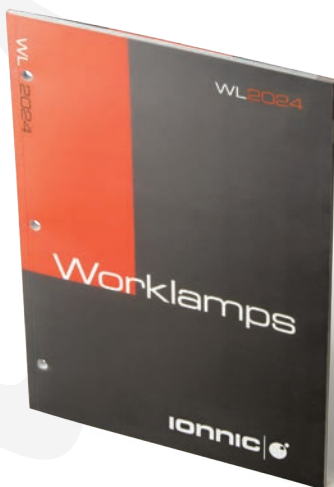
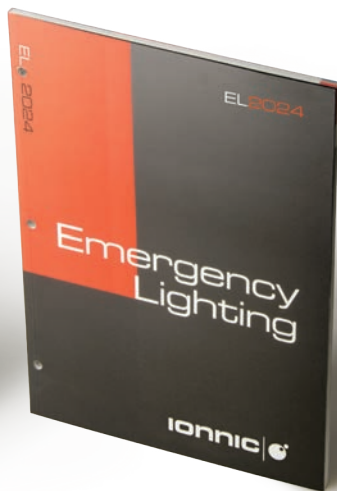

To find all the most up to date catalogues visit ionnic.com

General Information

WL 2024 Version 4.2 – 12/2023

This reference manual supersedes all previous editions.

Auto Electrical Imports Pty. Ltd. reserves the right to change, or discontinue products or specifications without notice. All data and assistance is given as a general guide only and the final decision on suitability and application must be with the customer.

Warranty Statement

Auto Electrical Imports Pty. Ltd. warrants the replacement only of products for a period of 12 months, unless otherwise stated, from date of purchase against faulty workmanship and material components.

Disassembly or modification of products may void warranty.

Warranty claims may only be returned by prior arrangement.

For a full statement outlining our warranty visit www.ionnic.com/warranty-statement

Copyright

This publication is copyright.
All rights reserved.

This publication may not be reproduced in full or in part by any means (electronic or mechanical) without the prior written permission of Auto Electrical Imports Pty. Ltd.

ionnic and the ionnic mark are trademarks of IONNIC Pty. Ltd., registered in Australia and other countries, used under licence by Auto Electrical Imports Pty. Ltd.

All other brand or product names are trademarks or registered trademarks of their respective owners.



WL2024



ionnic.com

For details of your nearest reseller free call:

1800 724 690

ionnic.com

Lighting | Safety | Electrical