

---

# DT Series



# DT Series



DT Series 8



DT Detector Half Kits 18



DTV Series 19



DT-XT Series 20



DTM Series 22



Assortment Kits 28



DTP Series 33



DTHD Series 36

# DT Series

DT Series

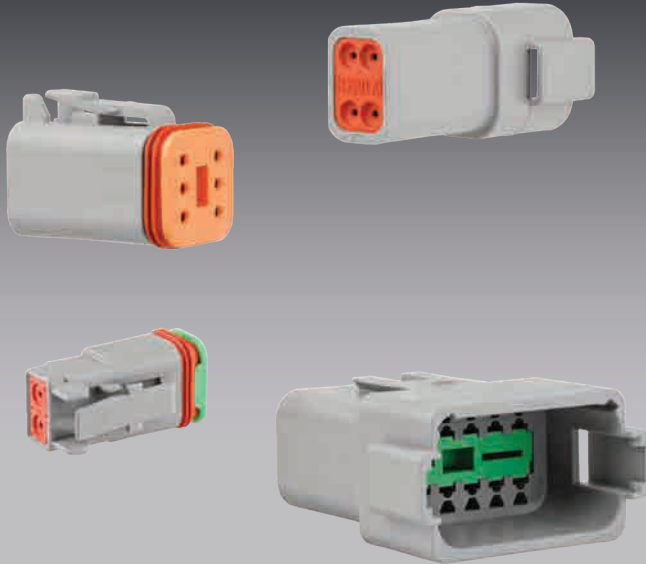

- Environmentally sealed – IP68, IP6K9K, when installed to manufacturer’s specifications.
- 2, 3, 4, 6, 8 and 12 cavity arrangements.
- Latched mating.
- Wedgelocks ensure contact alignment and retention.
- Accepts size 16 contacts, each with 13A continuous capacity.
- Available in kits with Solid Green Band, Solid – Gold-plated, and F-Crimp contact options.
- CAT-Spec kit option.
- Kits available containing all components required to make one (half kits), or both sides of a connection.
- The P012 enhanced seal is now standard for the DT Series 2 & 3 cavity plugs.

Housing :	Thermoplastic
Seal :	Silicone Rubber
Wedglock :	Thermoplastic
Contact Size :	16
Contact Rating :	13A @ 125°C
Shock :	50G
Vibration :	20G rms 10 – 2000Hz
Approvals :	20mm Flame Test per Standard UL-94
Ingress Protection :	IP68, IP6K9K
Operating Temperature :	-55°C to 125°C

## Part Numbering System

DT 04 – 08 P A – L012

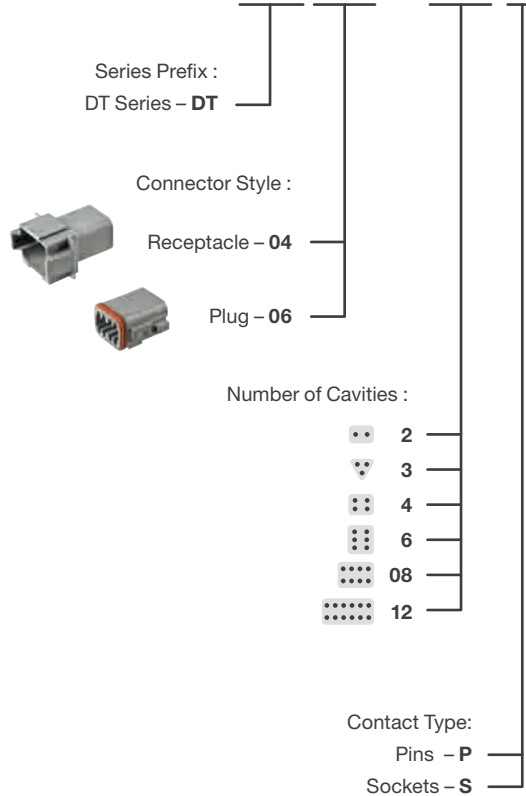

### Popular Special Modifications :

- **blank** – No modification.
- **C015** – Reduced diameter seal (E Seal).
- **E005** – Protective end cap. Black.
- **E008** – Heat shrink adaptor.
- **EP06** – Enhanced front seal (P012) and end cap.
- **EP08** – Enhanced front seal (P012) and end cap. Black.
- **L012** – Flange Mount receptacle.
- **P012** – Enhanced front seal.

For a complete list of special modifications see page 115–119

### Keying Options :

- **blank** – no keying
- **A** – Grey housing
- **B** – Black housing
- **C** – Green housing
- **D** – Brown housing

Keying Option is only available with 08 and 12 cavity housings.

**Temporary Green & Brown Housing Change**  
Due to material shortages, some green & brown housing connectors may use a grey housing with a green/brown seal retention cap, until further notice.

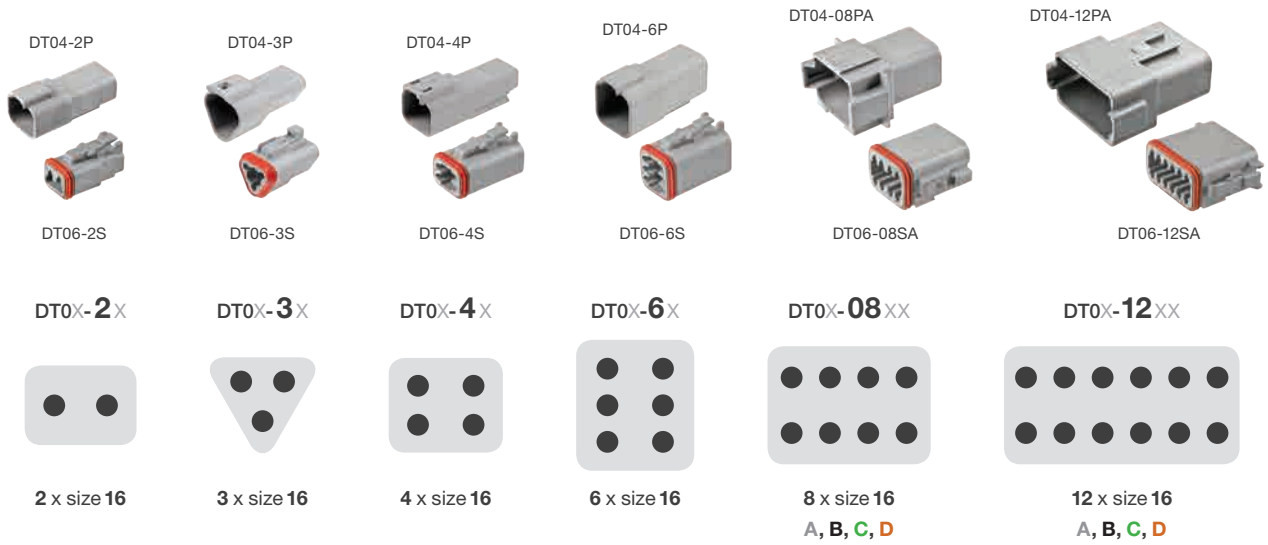

## DT Series – Popular Components

Circuits	Housing	Receptacle Components		Circuits	Housing	Plug Components	
		Wedglock	Size 16 Pin – Nickel			Wedglock	Size 16 Socket – Nickel
2	<b>DT04-2P</b>	<b>W2P</b>	<b>0460-202-16141</b> AWG20-16 / 0.5-1.0mm <sup>2</sup>	2	<b>DT06-2S</b>	<b>W2S-P012</b>	<b>0462-201-16141</b> AWG20-16 / 0.5-1.0mm <sup>2</sup>
3	<b>DT04-3P</b>	<b>W3P</b>	Green Band <b>0460-215-16141</b> AWG14 / 1.0-2.0mm <sup>2</sup>	3	<b>DT06-3S</b>	<b>W3S-P012</b>	Green Band <b>0462-209-16141</b> AWG14 / 1.0-2.0mm <sup>2</sup>
4	<b>DT04-4P</b>	<b>W4P</b>		8	<b>DT06-4S</b>	<b>W4S</b>	
6	<b>DT04-6P</b>	<b>W6P</b>	<b>114017</b> Cavity Plug	6	<b>DT06-6S</b>	<b>W6S</b>	<b>114017</b> Cavity Plug
8	<b>DT04-08PA</b>	<b>W8P</b>		8	<b>DT06-08SA</b>	<b>W8S</b>	
12	<b>DT04-12PA</b>	<b>W12P</b>		12	<b>DT06-12SA</b>	<b>W12S</b>	

For complete details on contacts & further options see page 98

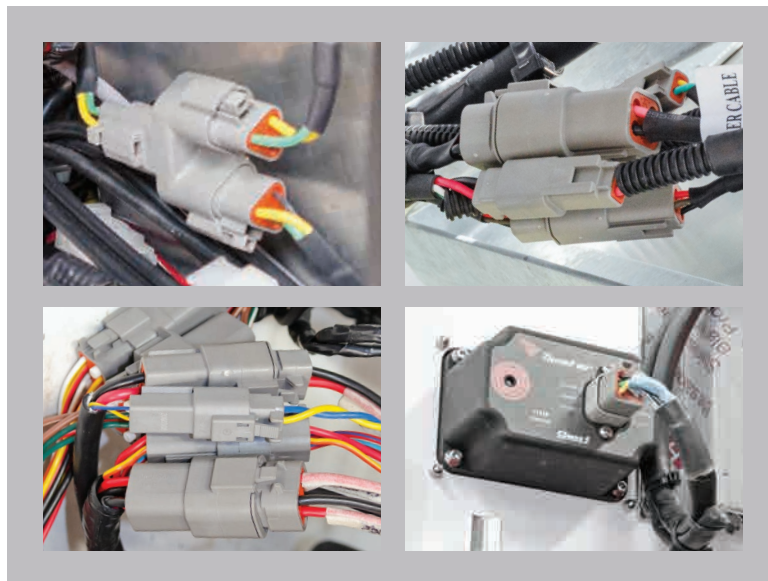

# DT Series

## Popular DT Series Special Modifications

### C015

Reduced diameter seal (E Seal) cavity for use with thin wall cable.

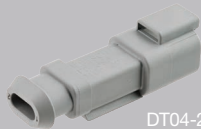

DT04-2P-E008

### DT04-4P-C015



### E008

Heat shrink adaptor.

Shown with W6S-P012 wedgelock



### DT06-6S-P012



### P012

Enhanced front seal. Provides an ultra tight environmental seal. Used in conjunction with P012 wedgelocks to enhance seal retention during mating and unmating.

Black housing excluding 8 and 12 cavity, where the colour is based on keying.

All 2 & 3 cavity DT Series connectors now feature the P012 seal as standard. All 2 & 3 cavity wedgelocks are P012 (green) as standard.

### EP09

Plug with enhanced seal retention (P012), latch guard end cap, black.



DT06-3S-EP11

### DT06-3S-EP09



### EP11

Plug with enhanced seal retention (P012), heat shrink adaptor, black.

Featured on page 91.

### PP01

Plug with enhanced seal retention (P012), 120 Ohm terminating resistor (J1939), end cap, black.

### DT06-3S-PP01



### EP13

Bussed receptacle, 4 and 6 way only. 1 x buss, black, nickel-plated pins. Featured on page 87.



DT04-6P-EP14

### DT04-4P-EP13



### EP14

Bussed receptacle, 6 way, 2 busses, black, nickel-plated pins. Featured on page 87.

### TN81

Snap on heat shrink adaptor.

NEW

### DT06-2S-TN81



## 'CAT-Spec' Modifications



DT04-3P-E005  
E005



DT06-6S-EP06  
EP06



DT06-12SA-EP08  
EP08

### L012

Flange mount receptacle.



DT06-3S-P006

### DT04-2P-L012



### P006

120 Ohm terminating resistor (J1939). Featured on page 91.

### P007

Receptacle Y connector (J1939). Featured on page 91.

### DT04-3P-P007



- Black.
- Rear end cap.
- Improved seal retention (plugs).

The DT Series connector housings with suffix E005, EP06 & EP08 are typically referred to as 'CAT-Spec', short for CATERPILLAR Specification. These modified housings are used on most CATERPILLAR mining machinery as an OEM standard connector.

At a glance, they are black and feature a cap on the rear to retain the connectors' rear wire seal. The plugs include improved seal retention by using the P012 wedgelock.

**E005** – Receptacles only. Black.

**EP06** – Plugs only. 2, 3, 4 & 6 cavity are black.

8 & 12 cavity are grey – this makes them exempt from being 'CAT-Spec'.

**EP08** – Plugs only. 8 & 12 cavities only. Black.

All modifications that include a cap are being standardised to a black cap. As stock transitions, some orders may still include the previous design. If this is an issue, please contact your reseller.



DT06-2S-E008

For a complete list of special modifications see page 115–119



DT04-2P-L012



DT04-6P



DT04-12PA-E005



DT06-3S



DT06-6S-EP06



DT06-08SA-E008

## DT Series – Housings – Receptacles

Cavities	Part No.	Pack Quantities				Bulk Box
		1	10	50	100	
2	DT04-2P	—	•	•	•	1000
	DT04-2P-C015	•	•	—	—	1000
	DT04-2P-E005	•	•	•	•	950
	DT04-2P-E008	•	•	•	•	800
	DT04-2P-L012	•	•	•	—	400
3	DT04-3P	—	•	•	•	850
	DT04-3P-C015	•	•	—	—	850
	DT04-3P-E005	•	•	•	•	800
	DT04-3P-E008	•	•	•	•	600
	DT04-3P-L012	•	•	—	—	450
	DT04-3P-P006	•	•	•	•	750
	DT04-3P-P007	•	•	•	—	200
4	DT04-4P	—	•	•	•	700
	DT04-4P-C015	•	•	•	—	700
	DT04-4P-E005	•	•	•	•	700
	DT04-4P-E008	•	•	•	•	500
	DT04-4P-EP13	•	•	—	•	700
	DT04-4P-L012	•	•	•	—	350
6	DT04-6P	•	•	•	•	600
	DT04-6P-C015	•	•	—	—	600
	DT04-6P-E005	•	•	•	•	500
	DT04-6P-E008	•	•	•	—	450
	DT04-6P-EP13	•	•	—	—	500
	DT04-6P-EP14	•	•	—	—	500
	DT04-6P-L012	•	•	•	—	400
8	DT04-08PA	•	•	•	•	350
	DT04-08PA-C015	•	•	—	—	350
	DT04-08PA-E005	•	•	•	—	300
	DT04-08PA-E008	•	•	—	—	250
	DT04-08PA-L012	•	•	—	—	200
12	DT04-12PA	•	•	•	—	300
	DT04-12PA-C015	•	•	—	—	300
	DT04-12PA-E005	•	•	•	—	250
	DT04-12PA-E008	•	•	—	—	250
	DT04-12PA-L012	•	•	—	—	200
	DT04-12PB	•	•	—	—	300

## DT Series – Housings – Plugs

Cavities	Part No.	Pack Quantities				Bulk Box
		1	10	50	100	
2	DT06-2S	—	•	•	•	1800
	DT06-2S-C015	•	•	•	—	1800
	DT06-2S-E008	•	•	•	•	1200
	DT06-2S-EP06	•	•	•	•	1600
3	DT06-3S	—	•	•	•	1400
	DT06-3S-C015	•	•	•	—	1400
	DT06-3S-E008	•	•	•	•	900
	DT06-3S-EP06	•	•	•	•	1200
	DT06-3S-EP09	•	•	—	•	1100
	DT06-3S-EP11	•	•	—	—	900
	DT06-3S-P006	•	•	—	—	1000
DT06-3S-PP01	•	•	—	—	1000	
4	DT06-4S	—	•	•	•	1200
	DT06-4S-E008	•	•	—	•	800
	DT06-4S-EP06	•	•	•	•	1000
6	DT06-6S	•	•	•	•	900
	DT06-6S-C015	•	•	—	—	900
	DT06-6S-E008	•	•	•	•	550
	DT06-6S-EP06	•	•	•	•	800
8	DT06-08SA	•	•	•	•	550
	DT06-08SA-C015	•	•	—	—	550
	DT06-08SA-E008	•	•	•	—	400
	DT06-08SA-EP06	•	•	—	—	500
	DT06-08SA-EP08	•	•	•	—	500
12	DT06-12SA	•	•	•	—	500
	DT06-12SA-C015	•	•	—	—	500
	DT06-12SA-E008	•	•	•	—	350
	DT06-12SA-EP06	•	•	—	—	450
	DT06-12SA-EP08	•	•	•	—	450
	DT06-12SB	•	•	—	—	500
	DT06-12SB-EP06	•	•	—	—	450
	DT06-12SC	•	•	—	—	500
DT06-12SD	•	•	—	—	500	

Bulk Boxes are available for the complete range of TE DEUTSCH upon request, lead times may apply.



# DT Series

## DT Series Kit Types

**DTX**  
Standard Connector  
with  
F-Crimp Contacts



**DTX-1**  
Standard Connector  
with  
Solid Green Band  
Contacts



**DTX-3**  
Standard Connector  
with  
Solid Contacts



**DTX-4**  
Standard Connector  
with  
Solid Green Band  
Gold-plated Contacts



**DT2A-1**  
Standard with A Keying Connector  
with  
Solid Green Band  
Contacts



**DTX-1-E008**  
Heat Shrink Adaptor Connector  
with  
Solid Green Band  
Contacts



**DT2-1B**  
Black Connector  
with  
Solid Green Band  
Contacts



**DT2A-1B**  
Black with A Keying Connector  
with  
Solid Green Band  
Contacts



**DTX-1-L012**  
Flange Mount Connector  
with  
Solid Green Band  
Contacts



**DTX-1-CAT**  
CAT-Spec Connector  
with  
Solid Green Band  
Contacts



**DTX-4-CAT**  
CAT-Spec Connector  
with  
Solid Green Band  
Gold-plated Contacts



### Size 16 Green Band Contacts

Size 16 solid contacts are available to suit 2 wire sizes.  
Contacts with the Green Band marking accept the larger  
wire size of AWG14 / 1.0 – 2.0mm<sup>2</sup>.



## DT Series – Kits

Cavities	Connector Type	Contact Type (Size 16)	Part No.	Pack Quantities					
				1	10	100	500	1000	
2	Standard	F-Crimp	DT2	●	—	—	—	—	
		Solid – Green Band	DT2-1	●	●	●	●	●	
		Solid	DT2-3	●	—	—	—	—	
		Solid – Green Band Gold-plated	DT2-4	●	—	—	—	—	
	Standard – A Keying	Solid – Green Band	DT2A-1	●	—	—	—	—	
	Flange Mount	Solid – Green Band	DT2-1-L012	●	—	—	—	—	
	Heat Shrink Adaptor	Black	Solid – Green Band	DT2-1-E008	●	—	—	—	—
		Black – A Keying	Solid – Green Band	DT2-1B	●	—	—	—	—
	CAT-Spec	Solid – Green Band	DT2-1-CAT	●	—	—	—	—	
		Solid – Green Band Gold-plated	DT2-4-CAT	●	—	—	—	—	
	3	Standard	F-Crimp	DT3	●	—	—	—	—
			Solid – Green Band	DT3-1	●	●	●	●	—
Solid			DT3-3	●	—	—	—	—	
Solid – Green Band Gold-plated			DT3-4	●	—	—	—	—	
Flange Mount		Solid – Green Band	DT3-1-L012	●	—	—	—	—	
Heat Shrink Adaptor		Solid – Green Band	DT3-1-E008	●	—	—	—	—	
		Solid – Green Band	DT3-1-CAT	●	—	—	—	—	
CAT-Spec		Solid – Green Band Gold-plated	DT3-4-CAT	●	—	—	—	—	
		Solid – Green Band	DT3-1-CAT	●	—	—	—	—	
4		Standard	F-Crimp	DT4	●	—	—	—	—
	Solid – Green Band		DT4-1	●	●	●	●	—	
	Solid		DT4-3	●	—	—	—	—	
	Solid – Green Band Gold-plated		DT4-4	●	—	—	—	—	
	Flange Mount	Solid – Green Band	DT4-1-L012	●	—	—	—	—	
	Heat Shrink Adaptor	Solid – Green Band	DT4-1-E008	●	—	—	—	—	
		Solid – Green Band	DT4-1-CAT	●	—	—	—	—	
	CAT-Spec	Solid – Green Band Gold-plated	DT4-4-CAT	●	—	—	—	—	
		Solid – Green Band	DT4-1-CAT	●	—	—	—	—	
	6	Standard	F-Crimp	DT6	●	—	—	—	—
Solid – Green Band			DT6-1	●	●	●	—	—	
Solid			DT6-3	●	—	—	—	—	
Solid – Green Band Gold-plated			DT6-4	●	—	—	—	—	
Flange Mount		Solid – Green Band	DT6-1-L012	●	—	—	—	—	
Heat Shrink Adaptor		Solid – Green Band	DT6-1-E008	●	—	—	—	—	
		Solid – Green Band	DT6-1-CAT	●	—	—	—	—	
CAT-Spec		Solid – Green Band Gold-plated	DT6-4-CAT	●	—	—	—	—	
		Solid – Green Band	DT6-1-CAT	●	—	—	—	—	
8		Standard	F-Crimp	DT8	●	—	—	—	—
	Solid – Green Band		DT8-1	●	●	●	—	—	
	Solid		DT8-3	●	—	—	—	—	
	Solid – Green Band Gold-plated		DT8-4	●	—	—	—	—	
	Flange Mount	Solid – Green Band	DT8-1-L012	●	—	—	—	—	
	Heat Shrink Adaptor	Solid – Green Band	DT8-1-E008	●	—	—	—	—	
		Solid – Green Band	DT8-1-CAT	●	—	—	—	—	
	CAT-Spec	Solid – Green Band Gold-plated	DT8-4-CAT	●	—	—	—	—	
		Solid – Green Band	DT8-1-CAT	●	—	—	—	—	
	12	Standard	F-Crimp	DT12	●	—	—	—	—
Solid – Green Band			DT12-1	●	●	●	—	—	
Solid			DT12-3	●	—	—	—	—	
Solid – Green Band Gold-plated			DT12-4	●	—	—	—	—	
Flange Mount		Solid – Green Band	DT12-1-L012	●	—	—	—	—	
Heat Shrink Adaptor		Solid – Green Band	DT12-1-E008	●	—	—	—	—	
		Solid – Green Band	DT12-1-CAT	●	—	—	—	—	
CAT-Spec		Solid – Green Band Gold-plated	DT12-4-CAT	●	—	—	—	—	
		Solid – Green Band	DT12-1-CAT	●	—	—	—	—	

Kit Contents: 1 x Receptacle & Wedgelock, 1 x Plug & Wedgelock, Contacts to suit



# DT Series

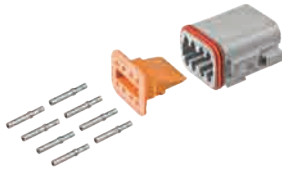

DT8FP-1



DT4MP-1

## Half Kits

Half Kits contain all components to make one half of a connection.

Each kit contains **Green Band** contacts and a standard DT Series housing with appropriate wedgelock.

## DT Series – Half Kits

Style	Contact Type (Size 16)	No. of Cavities					
		2	3	4	6	8	12
Receptacle	Solid – Green Band	<b>DT2MP-1</b>	<b>DT3MP-1</b>	<b>DT4MP-1</b>	<b>DT6MP-1</b>	<b>DT8MP-1</b>	<b>DT12MP-1</b>
Plug	Solid – Green Band	<b>DT2FP-1</b>	<b>DT3FP-1</b>	<b>DT4FP-1</b>	<b>DT6FP-1</b>	<b>DT8FP-1</b>	<b>DT12FP-1</b>

Kit Contents:  
1 x Housing & Wedgelock  
Contacts to suit

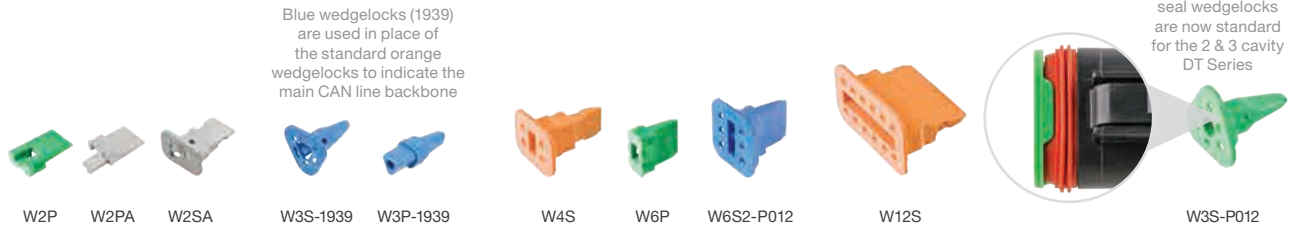

## DT Series – Wedgelocks

Cavities	Type	Suits	Part No.	Pack Quantities					Bulk Box
				1	10	50	100	1000	
2	Standard	Receptacles	<b>W2P</b>	—	●	●	●	●	22,000
	Enhanced Seal	Plugs	<b>W2S-P012</b>	—	●	●	●	●	8000
	A Keying	Receptacles	<b>W2PA</b>	●	—	—	—	—	—
	A Keying	Plugs	<b>W2SA</b>	●	—	—	—	—	—
3	Standard	Receptacles	<b>W3P</b>	—	●	●	●	●	20,000
	Enhanced Seal	Plugs	<b>W3S-P012</b>	—	●	●	●	●	6000
	J1939	Plugs	<b>W3S-1939</b>	●	●	●	●	—	—
	J1939 Enhanced Seal	Plugs	<b>W3S-1939-P012</b>	●	●	●	●	—	—
	J1939	Receptacles	<b>W3P-1939</b>	●	●	●	●	—	—
4	Standard	Receptacles	<b>W4P</b>	—	●	●	●	—	15,000
	Standard	Plugs	<b>W4S</b>	—	●	●	●	—	5000
	Enhanced Seal	Plugs	<b>W4S-P012</b>	—	●	●	●	—	6000
6	Standard	Receptacles	<b>W6P</b>	—	●	●	●	—	10,000
	Standard	Plugs	<b>W6S</b>	—	●	●	●	—	3500
	Enhanced Seal	Plugs	<b>W6S-P012</b>	—	●	●	●	—	4000
	Enhanced Seal	Plugs	<b>W6S2-P012</b>	●	—	—	—	—	—
8	Standard	Receptacles	<b>W8P</b>	●	●	●	●	—	5000
	Standard	Plugs	<b>W8S</b>	●	●	●	●	—	2500
	Enhanced Seal	Plugs	<b>W8S-P012</b>	●	●	●	●	—	2000
12	Standard	Receptacles	<b>W12P</b>	●	●	●	●	—	5000
	Standard	Plugs	<b>W12S</b>	●	●	●	●	—	2000
	Enhanced Seal	Plugs	<b>W12S-P012</b>	●	●	●	●	—	2000

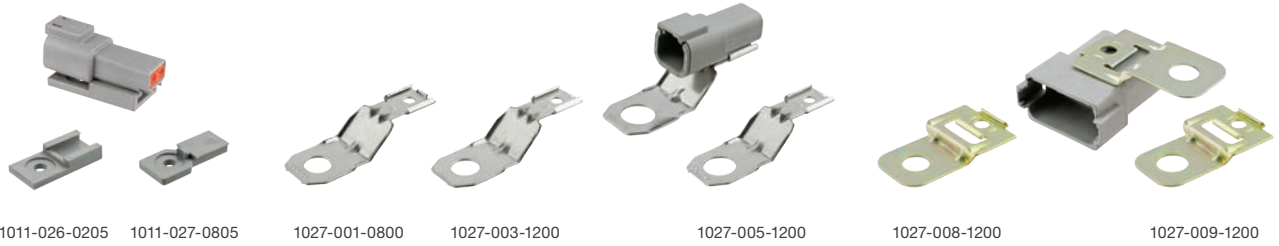

## DT Series – Mounting Clips

Part No.	Suits	Mounting Direction	Material	Mounting Hole Ø (mm)	Pack Quantities				
					1	10	25	50	100
<b>1011-026-0205</b>	All except 8 cavity	Straight	Thermoplastic	5	•	•	—	•	•
<b>1011-027-0805</b>	8 cavity connectors only	Straight	Thermoplastic	5	•	•	—	•	•
<b>1027-001-0800</b>	8 cavity connectors only	Straight	Stainless steel	11	•	•	•	—	•
<b>1027-003-1200</b>	All except 8 cavity	Straight	Stainless steel	11	•	•	•	—	•
<b>1027-005-1200</b>	All except 8 cavity	Straight	Stainless steel	13	•	•	•	—	•
<b>1027-008-1200</b>	All except 8 cavity	Side	Zinc-plated steel	11	•	•	•	—	•
<b>1027-009-1200</b>	All except 8 cavity	Side	Zinc-plated steel	13	•	•	•	—	•

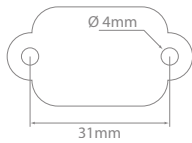

## DT Series – Special – Flange Mount Receptacle

Part No.	Description	Wire Length	Mating Plug
<b>DT2-PM</b>	2 pin flange mount receptacle with soldered wires and rubber sealing gasket	40mm	DT06-2S

Third party manufactured.



## DT Series – Flange Mount – Gaskets

Part No.	No. of Cavities					
	2	3	4	6	8	12
—	<b>DT3P-L012-GKT</b>	<b>DT4P-L012-GKT</b>	—	<b>DT8P-L012-GKT</b>	<b>DT12P-L012-GKT</b>	
Suits	—	DT04-3P-L012	DT04-4P-L012	—	DT04-08PA-L012	DT04-12PA-L012



# DT Series



## DT Series – Insulators/Boots

	Colour	No. of Cavities					
		2	3	4	6	8	12
Receptacles – 120mm	Black	<b>DTB2P</b>	<b>DTB3P</b>	<b>DTB4P</b>	<b>DTB6P</b>	<b>DTB8P</b>	<b>DTB12P</b>
Plugs – 120mm	Black	<b>DTB2S</b>	<b>DTB3S</b>	<b>DTB4S</b>	<b>DTB6S</b>	<b>DTB8S</b>	<b>DTB12S</b>
Receptacles – 65mm	Grey	<b>DT2P-BT</b>	<b>DT3P-BT</b>	<b>DT4P-BT</b>	<b>DT6P-BT</b>	<b>DT8P-BT</b>	<b>DT12P-BT</b>
Plugs – 65mm	Grey	<b>DT2S-BT</b>	<b>DT3S-BT</b>	<b>DT4S-BT</b>	<b>DT6S-BT</b>	<b>DT8S-BT</b>	<b>DT12S-BT</b>
Receptacles – 65mm	Black	<b>DT2P-BT-BK</b>	<b>DT3P-BT-BK</b>	<b>DT4P-BT-BK</b>	<b>DT6P-BT-BK</b>	<b>DT8P-BT-BK</b>	<b>DT12P-BT-BK</b>

Material: Plastisol.

DT06-6S



## DT Series – Dust Caps – Thermoplastic

	No. of Cavities					
	2	3	4	6	8	12
Part No.	<b>1011-344-0205</b>	<b>1011-345-0305</b>	<b>1011-346-0405</b>	<b>1011-347-0605</b>	<b>1011-348-0805</b>	<b>1011-349-1205</b>
Suits	DT06-2S	DT06-3S	DT06-4S	DT06-6S	DT06-08S	DT06-12S



## DT Series – Dust Caps – Receptacles NEW

	No. of Cavities		
	3	4	6
Part No.	<b>DT3P-DC</b>	<b>DT4P-DC</b>	<b>DT6P-DC</b>
Suits	DT04-3P	DT04-4P	DT04-6P

Material – Plastisol.

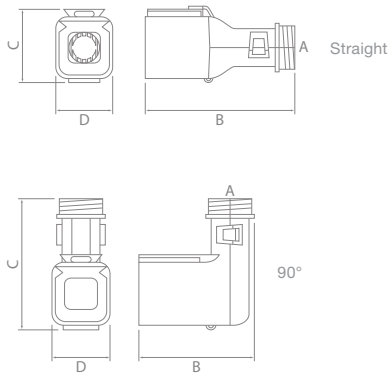

1011-257-0205



1011-250-1205



## DT Series – Backshells – Receptacles

Straight	90°	Suits	A (NW)	A (NC)	B (mm)	C (mm)	D (mm)
<b>1011-257-0205</b>	<b>1011-258-0205</b>	DT04-2P	7.5, 8.5, 10	8, 10, 12	55	20	45
<b>1011-261-0305</b>	<b>1011-262-0305</b>	DT04-3P	7.5, 8.5, 10	8, 10, 12	65	27	56
<b>1011-265-0405</b>	<b>1011-266-0405</b>	DT04-4P	7.5, 8.5, 10	8, 10, 12	59	24	53
<b>1011-269-0605</b>	<b>1011-270-0605</b>	DT04-6P	8.5, 10, 13	10, 12, 16	65	28	55
<b>1011-245-0805</b>	<b>1011-246-0805</b>	DT04-08P	8.5, 10, 13	10, 12, 16	62	30	57
<b>1011-249-1205</b>	<b>1011-250-1205</b>	DT04-12P	12, 13, 17	14, 16, 20	64	29	59

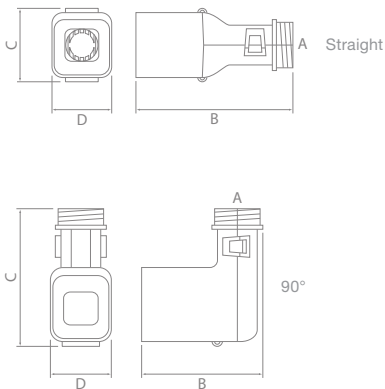

1011-260-0305



1011-247-1205



## DT Series – Backshells – Plugs

Straight	90°	Suits	A (NW)	A (NC)	B (mm)	C (mm)	D (mm)
<b>1011-255-0205</b>	<b>1011-256-0205</b>	DT06-2S	7.5, 8.5, 10	8, 10, 12	42	37	32
<b>1011-259-0305</b>	<b>1011-260-0305</b>	DT06-3S	7.5, 8.5, 10	8, 10, 12	46	48	37
<b>1011-263-0405</b>	<b>1011-264-0405</b>	DT06-4S	7.5, 8.5, 10	8, 10, 12	44	45	35
<b>1011-267-0605</b>	<b>1011-268-0605</b>	DT06-6S	8.5, 10, 13	10, 12, 16	45	50	39
<b>1011-243-0805</b>	<b>1011-244-0805</b>	DT06-08S	8.5, 10, 13	10, 12, 16	49	51	41
<b>1011-247-1205</b>	<b>1011-248-1205</b>	DT06-12S	12, 13, 17	14, 16, 20	55	51	45



# DT Series

## DT Detector Half Kits

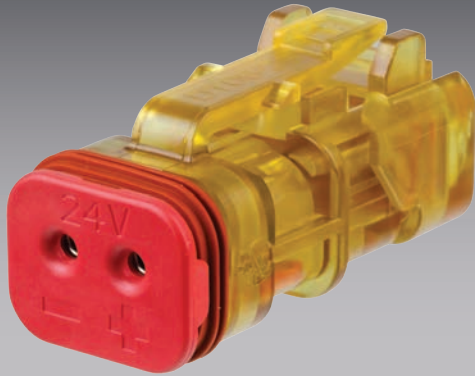

- Transparent housing with integrated LED on wedge lock for quick circuit diagnosis.
- Colour coded wedge locks for operating voltages, 12V (yellow) and 24V (red).
- Joint retention fingers allow both contacts to be removed at the same time.
- Compatible with Pulse Width Modulated control.
- Supplied as complete kit including nickel-plated and green band contacts.
- Environmentally sealed – IP66, when installed to manufacturer's specifications.
- Industry proven DT Series.
- Latched mating.

Housing :	Ultem
Seal :	Silicone Rubber
Wedge lock :	Thermoplastic
Contact Size :	16
Contact Rating :	13A @ 125°C
Shock :	50G
Vibration :	20G rms 10 – 2000Hz
Approvals :	20mm Flame Test per Standard UL-94
Ingress Protection :	IP66
Operating Temperature :	-55°C to 125°C



### Half Kits

Half Kits contain all components to make one half of a connection.

Each kit contains 2 x contacts and a DT Detector plug with a DT Detector Wedge lock.



## DT Detector Half Kits

Part No.	Voltage	Wedge lock Colour	Socket Type	Wire Size	
				AWG	mm <sup>2</sup>
<b>DTLED-12V-1</b>	12	Yellow	0462-209-16141 – Green Band Nickel-plated	14	1.0 – 2.0
<b>DTLED-24V-1</b>	24	Red	0462-209-16141 – Green Band Nickel-plated	14	1.0 – 2.0
<b>DTLED-12V-3</b>	12	Yellow	0462-201-16141 – Nickel-plated	20 – 16	0.5 – 1.0
<b>DTLED-24V-3</b>	24	Red	0462-201-16141 – Nickel-plated	20 – 16	0.5 – 1.0
<b>DTLED-12V-4</b>	12	Yellow	0462-209-1631 – Green Band Gold-plated	14	1.0 – 2.0
<b>DTLED-24V-4</b>	24	Red	0462-209-1631 – Green Band Gold-plated	14	1.0 – 2.0

Kit Contents:  
 1 x DT Detector Plug (DT06-2S-SDT-CE27)  
 1 x DT Detector Wedge lock (W2S-SDT-12V or W2S-SDT-24V)  
 2 x Solid Socket



DEUTSCH

- 18 cavity arrangement.
- Protective end cap as standard.
- Accepts size 16 contacts, each with 13A continuous capacity.
- Flange mount receptacle.
- Rectangular, thermoplastic housing.
- Latched mating.
- Wedgelocks ensure contact alignment and retention.

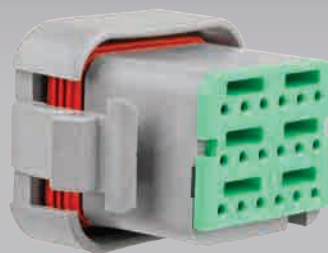
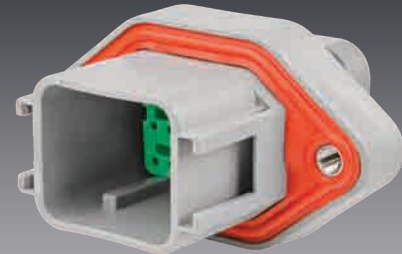

Housing :	Thermoplastic
Seal :	Silicone Rubber
Wedglock :	Thermoplastic
Contact Size :	16
Contact Rating :	13A @ 125°C
Shock :	50G
Vibration :	20G rms 10 – 2000Hz
Approvals :	20mm Flame Test per Standard UL-94
Operating Temperature :	-55°C to 125°C



## Part Numbering System

**DTV 02 – 18 S A**

Series Prefix :  
DTV Series – **DTV**

Connector Style :

Receptacle – **02**

Plug – **06**

Keying Options :

**A** – Grey housing

**B** – Black housing

**C** – Green housing

**D** – Brown housing

P – Pins  
S – Sockets

Contact Type

**18**



Number of Cavities

### Temporary **Brown** Housing Change

Due to material shortages, brown housing connectors may use a grey housing with a brown seal retention cap, until further notice.



DTV02-18PA



DTV02-18PB



WV-18P



DTV06-18SA



DTV06-18SB



WV-18S

For complete details on contacts & further options see page 98

## DTV Series

Cavities	A Keying	B Keying (Black housing)	Style	Wedgelocks
18	<b>DTV02-18PA</b>	<b>DTV02-18PB</b>	Receptacle	<b>WV-18P</b>
18	<b>DTV06-18SA</b>	<b>DTV06-18SB</b>	Plug	<b>WV-18S</b>



# DT Series

DT-XT Series

**NEW**

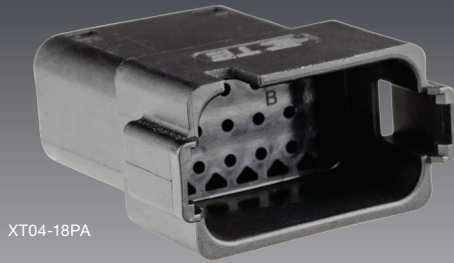

XT04-18PA



XT06-18SA

IP67 IP68 IP69K

- High performance seal and cover design – improved flexibility, tear resistance, and water ingress protection.
- Advanced seal materials offer greater flexibility and tear resistance.
- Rear seals constructed from high consistency rubber (HCR) – greater protection during contact insertion/extraction.
- Plug housing forms a covalent bond with the LSR seal improving mating/unmating longevity.
- Integrated rear cover protects the seal from cable exit bend radius issues.
- Pre-assembled and seal-tested.
- No wedgelock required.
- Corrugations on plug's locking latch for better grip when unmating.
- Environmentally sealed – IP67, IP68, IP69K, when installed to manufacturer's specifications.
- SAE J2030 power-wash tested.

Housing :	Thermoplastic
Rear Seals :	High Consistency Rubber (HCR)
Contact Size :	16
Contact Rating :	13A @ 125°C
Shock :	50G
Vibration :	20G rms 10 – 2000Hz
Approvals :	SAE J2030 Power-wash test capable
Ingress Protection :	IP67, IP68, IP69K
Operating Temperature :	-55°C to 125°C



For complete details on contacts & further options see page 98

## DT-XT Series **NEW**

Cavities	Receptacle	Plug
18	XT04-18PA	XT06-18SA

# IONNIC YouTube Channel

Product videos,  
configuration tutorials  
and more

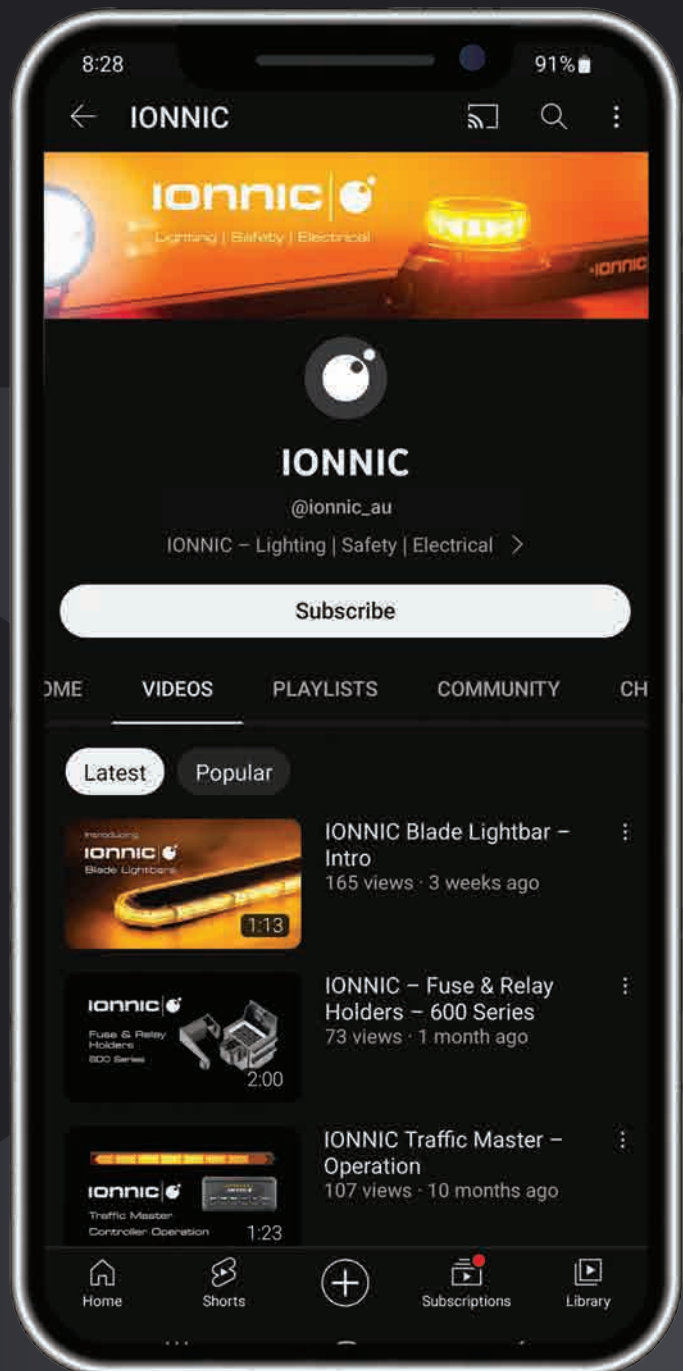

# DT Series

DTM Series

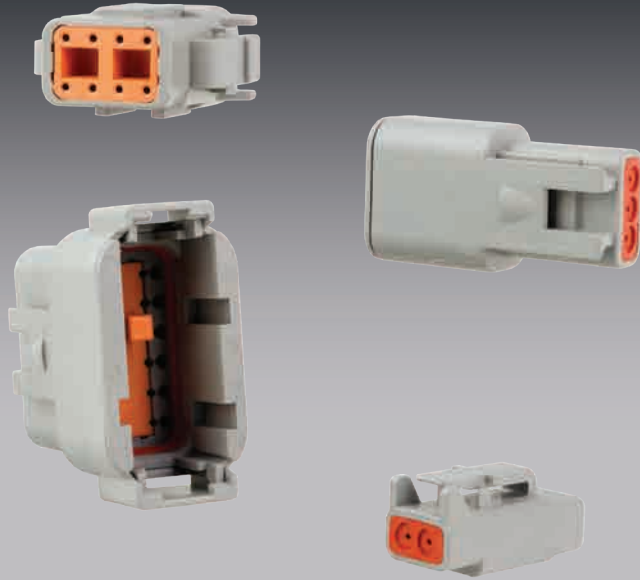

- Environmentally sealed – IP68, IP6K9K, when installed to manufacturer's specifications.
- 2, 3, 4, 6, 8 and 12 cavity arrangements.
- Latched mating.
- Wedgelocks ensure contact alignment and retention.
- Accepts size 20 contacts, each with 7.5A continuous capacity.
- Available in kits with Solid Purple Band, or Solid Gold-plated contact options.
- Each kit contains all components required to make both sides of a connection.

Housing :	Thermoplastic
Seal :	Silicone Rubber
Wedglock :	Thermoplastic
Contact Size :	20
Contact Rating :	7.5A @ 125°C
Shock :	50G
Vibration :	20G rms 10 – 2000Hz
Approvals :	20mm Flame Test per Standard UL-94
Ingress Protection :	IP68, IP6K9K
Operating Temperature :	-55°C to 125°C

## Part Numbering System

**DTM 06 - 12 S A - E007**

Series Prefix :  
DTM Series - **DTM**

Connector Style :



Receptacle - **04**



Plug - **06**

Number of Cavities :

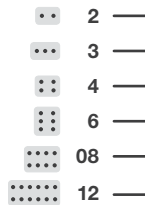

Contact Type:

Pins - **P**

Sockets - **S**

Popular Special Modifications :

- **blank** - No modification.
- **E007** - Heat shrink adaptor.
- **E004** - Black connector body.
- **P006** - 120 Ohm terminating resistor.
- **EP10** - 120 Ohm terminating resistor. Black.
- **L012** - Flange Mount receptacle.
- **P007** - Bussed receptacle, 6 way, 2 busses, Black.

For a complete list of special modifications see page 115-119

Keying Options :

- **blank** - no keying
- **A** - Grey housing
- **B** - Black housing
- **C** - Green housing
- **D** - Brown housing

Keying Option is only available with 08 and 12 cavity housings.

### Temporary Green & Brown Housing Change

Due to material shortages, some green & brown housing connectors may use a grey housing with a green/brown seal retention cap, until further notice.

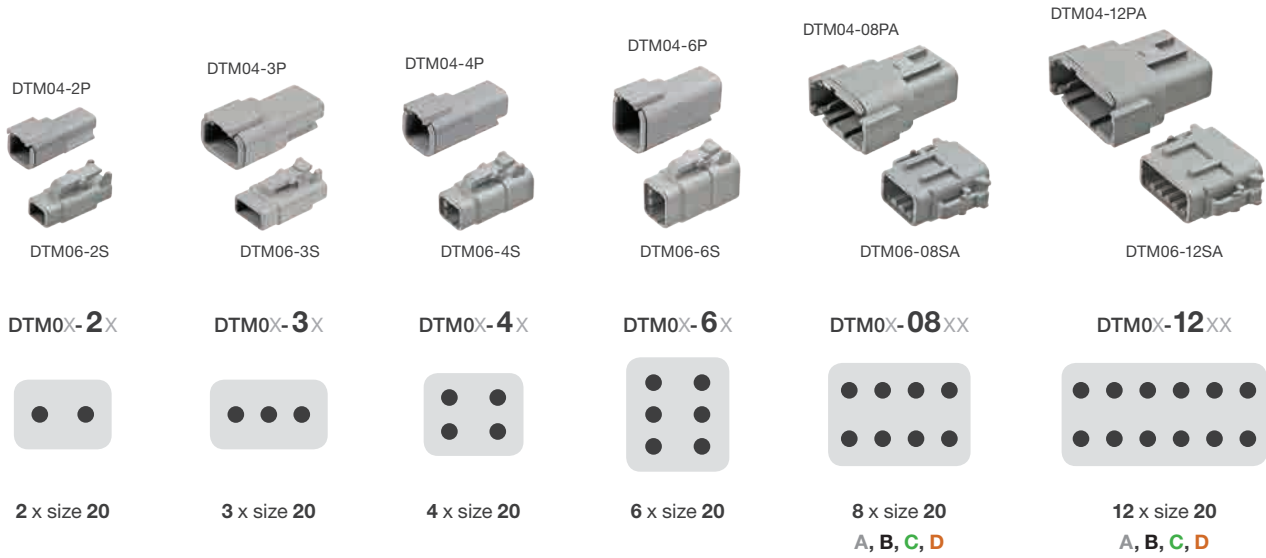

## DTM Series – Popular Components

Circuits	Receptacle Components			Plug Components		
	Housing	Wedgelock	Size 20 Pin – Nickel	Housing	Wedgelock	Size 20 Socket – Nickel
2	<b>DTM04-2P</b>	<b>WM-2P</b>	<b>0460-202-20141</b> AWG20 / 0.5mm <sup>2</sup>	<b>DTM06-2S</b>	<b>WM-2S</b>	<b>0462-201-20141</b> AWG20 / 0.5mm <sup>2</sup>
3	<b>DTM04-3P</b>	<b>WM-3P</b>		<b>DTM06-3S</b>	<b>WM-3S</b>	
4	<b>DTM04-4P</b>	<b>WM-4P</b>	Purple Band	<b>DTM06-4S</b>	<b>WM-4S</b>	Purple Band
6	<b>DTM04-6P</b>	<b>WM-6P</b>	<b>0460-010-20141</b> AWG18-16 / 0.75-1.3mm <sup>2</sup>	<b>DTM06-6S</b>	<b>WM-6S</b>	<b>0462-005-20141</b> AWG18-16 / 0.75-1.3mm <sup>2</sup>
8	<b>DTM04-08PA</b>	<b>WM-8P</b>		<b>DTM06-08SA</b>	<b>WM-8S</b>	
12	<b>DTM04-12PA</b>	<b>WM-12P</b>	<b>0413-204-2005</b> Cavity Plug	<b>DTM06-12SA</b>	<b>WM-12S</b>	<b>0413-204-2005</b> Cavity Plug

For complete details on contacts & further options see page 98



# DT Series

## Popular DTM Series Special Modifications

### E004

Black connector body.

DTM04-4P-E004

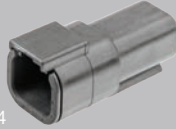

### E007

Heat shrink adaptor.

DTM04-2P-E007



### EP10

120 Ohm terminating resistor. Black.

DTM06-2S-EP10



### L012

Flange Mount receptacle.

DTM04-12PA-L012



### P006

120 Ohm terminating resistor.

DTM04-2P-P006



### P007

Bussed receptacle, 6 way, 2 busses, black, nickel-plated pins. Featured on page 93.

DTM04-2P-P007



For a complete list of special modifications see page 115-119



DTM04-2P-P006



DTM04-4P



DTM04-08PA



DTM06-3S-E007



DTM06-6S



DTM06-12SB

## DTM Series – Housings – Receptacles

Cavities	Part No.	Pack Quantities				
		1	10	50	100	Bulk Box
2	<b>DTM04-2P</b>	•	•	•	•	1200
	<b>DTM04-2P-E007</b>	•	•	–	–	1000
	<b>DTM04-2P-P006</b>	•	•	–	–	1000
	<b>DTM04-2P-P007</b>	•	•	–	–	200
3	<b>DTM04-3P</b>	•	•	•	•	1000
4	<b>DTM04-4P</b>	•	•	•	•	800
	<b>DTM04-6P</b>	•	•	•	•	650
8	<b>DTM04-08PA</b>	•	•	•	–	500
	<b>DTM04-12PA</b>	•	•	–	–	350
12	<b>DTM04-12PB</b>	•	•	–	–	350

## DTM Series – Housings – Plugs

Cavities	Part No.	Pack Quantities				
		1	10	50	100	Bulk Box
2	<b>DTM06-2S</b>	•	•	•	•	3000
	<b>DTM06-2S-E007</b>	•	•	•	–	2000
3	<b>DTM06-3S</b>	•	•	•	•	2000
	<b>DTM06-3S-E007</b>	•	•	•	–	1400
4	<b>DTM06-4S</b>	•	•	•	–	1600
	<b>DTM06-4S-E004</b>	•	•	–	–	1600
	<b>DTM06-4S-E007</b>	•	•	–	–	1200
6	<b>DTM06-6S</b>	•	•	•	–	1300
	<b>DTM06-6S-E007</b>	•	•	•	–	1000
8	<b>DTM06-08SA</b>	•	•	•	–	900
	<b>DTM06-08SA-E007</b>	•	•	–	–	600
12	<b>DTM06-12SA</b>	•	•	•	•	600
	<b>DTM06-12SA-E007</b>	•	•	–	–	500
	<b>DTM06-12SB</b>	•	•	•	–	600
	<b>DTM06-12SC</b>	•	•	–	–	600
	<b>DTM06-12SD</b>	•	–	–	–	–

Bulk Boxes are available for the complete range of TE DEUTSCH upon request, lead times may apply

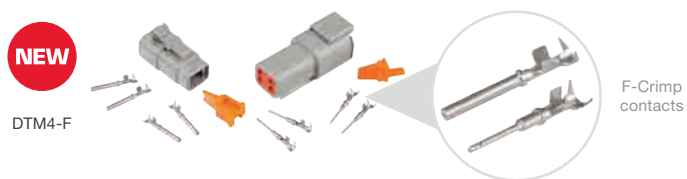
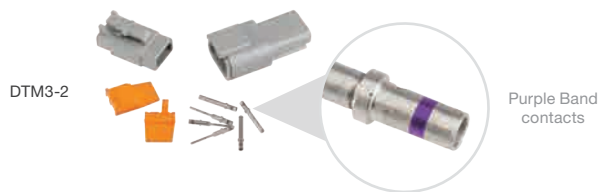
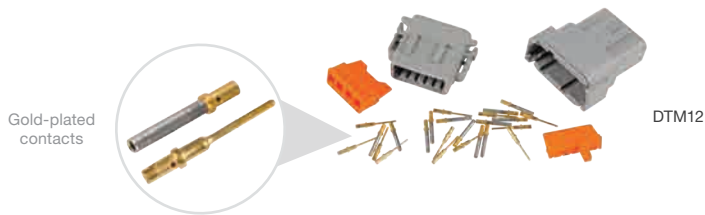
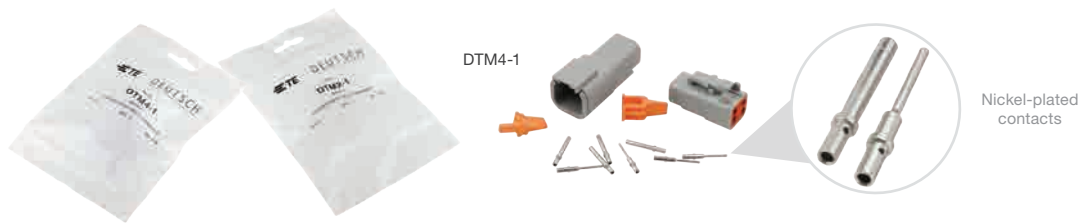

## DTM Series – Kits

Contact Type (Size 20)	Connector Type	Pack Quantity	No. of Cavities					
			2	3	4	6	8	12
Solid	Standard	1	DTM2-1	DTM3-1	DTM4-1	DTM6-1	DTM8-1	DTM12-1
		10	DTM2-1/10	DTM3-1/10	DTM4-1/10	DTM6-1/10	DTM8-1/10	DTM12-1/10
Solid – Gold-plated	Standard	1	DTM2	DTM3	DTM4	DTM6	DTM8	DTM12
		10	DTM2/10	DTM3/10	DTM4/10	DTM6/10	DTM8/10	DTM12/10
Solid – Purple Band	Standard	1	DTM2-2	DTM3-2	DTM4-2	DTM6-2	DTM8-2	DTM12-2
		10	DTM2-2/10	DTM3-2/10	DTM4-2/10	DTM6-2/10	DTM8-2/10	DTM12-2/10
Solid – Gold-plated <b>NEW</b>	E007 Mod.	1	DTM2-E007	DTM3-E007	DTM4-E007	—	—	—
F-Crimp <b>NEW</b>	Standard	1	DTM2-F	DTM3-F	DTM4-F	—	—	—

Kit Contents:  
 1 x Receptacle & Wedgelock  
 1 x Plug & Wedgelock  
 Contacts to suit



# DT Series

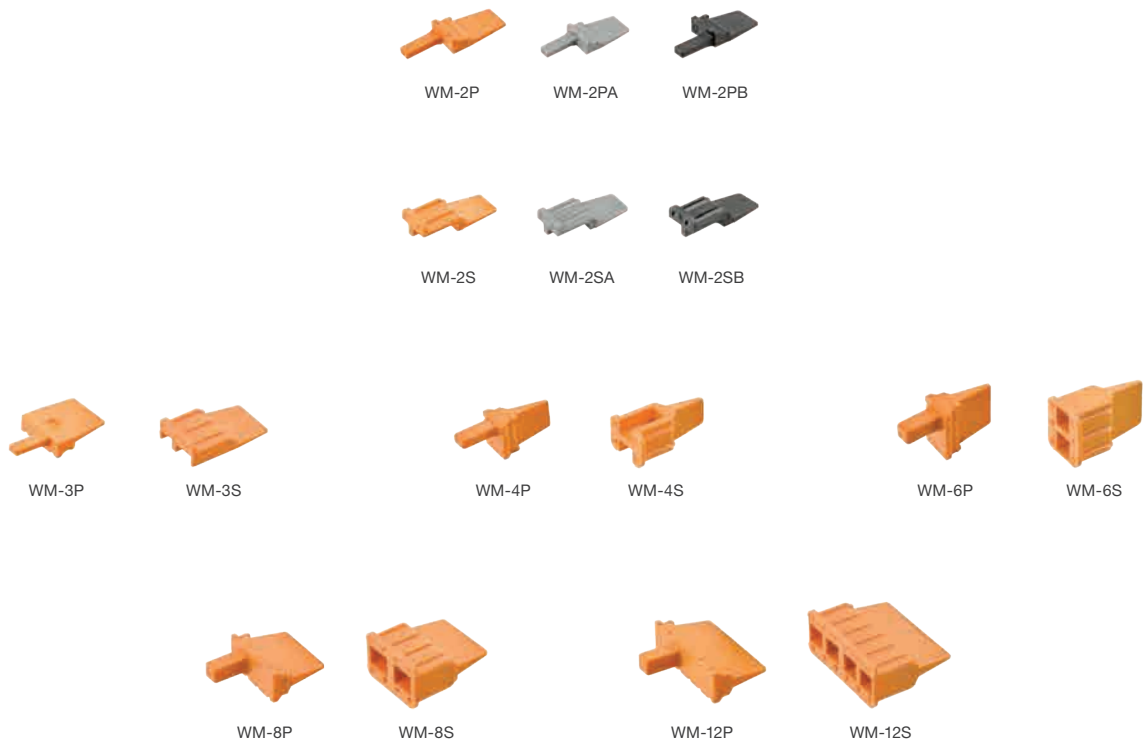

## DTM Series – Wedgelocks

Cavities	Type	Suits	Part No.	Pack Quantities			
				1	10	50	100
2	Standard	Receptacles	<b>WM-2P</b>	•	•	•	•
	A Keyed	Receptacles	<b>WM-2PA</b>	•	–	–	–
	B Keyed	Receptacles	<b>WM-2PB</b>	•	–	–	–
	Standard	Plugs	<b>WM-2S</b>	•	•	•	•
	A Keyed	Plugs	<b>WM-2SA</b>	•	–	–	–
	B Keyed	Plugs	<b>WM-2SB</b>	•	–	–	–
3	Standard	Receptacles	<b>WM-3P</b>	•	•	•	•
	Standard	Plugs	<b>WM-3S</b>	•	•	•	•
4	Standard	Receptacles	<b>WM-4P</b>	•	•	•	•
	Standard	Plugs	<b>WM-4S</b>	•	•	•	•
6	Standard	Receptacles	<b>WM-6P</b>	•	•	•	•
	Standard	Plugs	<b>WM-6S</b>	•	•	•	•
8	Standard	Receptacles	<b>WM-8P</b>	•	•	•	•
	Standard	Plugs	<b>WM-8S</b>	•	•	•	•
12	Standard	Receptacles	<b>WM-12P</b>	•	•	•	•
	Standard	Plugs	<b>WM-12S</b>	•	•	•	•

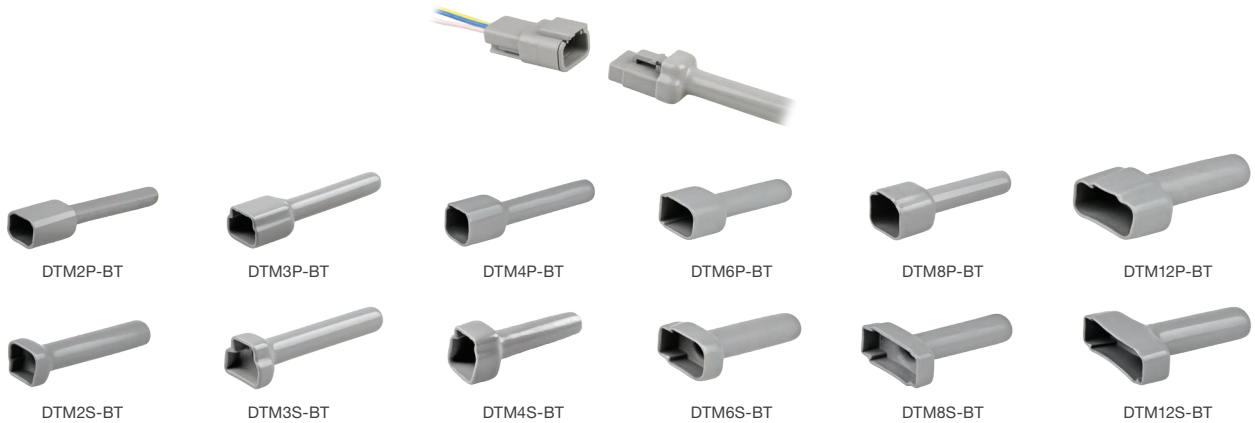

## DTM Series – Insulators/Boots

	Colour	No. of Cavities					
		2	3	4	6	8	12
Receptacles	Grey	<b>DTM2P-BT</b>	<b>DTM3P-BT</b>	<b>DTM4P-BT</b>	<b>DTM6P-BT</b>	<b>DTM8P-BT</b>	<b>DTM12P-BT</b>
Plugs	Grey	<b>DTM2S-BT</b>	<b>DTM3S-BT</b>	<b>DTM4S-BT</b>	<b>DTM6S-BT</b>	<b>DTM8S-BT</b>	<b>DTM12S-BT</b>

Material: Plastisol.



## DTM Series – Mounting Clips

Part No.	Suits	Mounting Direction	Material	Mounting Hole Ø (mm)	Pack Quantities			
					1	10	25	100
<b>1011-026-0205</b>	All except 8 cavity	Straight	Thermoplastic	5	●	—	—	—
<b>1011-027-0805</b>	8 cavity connectors only	Straight	Thermoplastic	5	●	—	—	—
<b>1027-001-0800</b>	8 cavity connectors only	Straight	Stainless steel	11	●	●	●	●
<b>1027-003-1200</b>	All except 8 cavity	Straight	Stainless steel	11	●	●	●	●
<b>1027-005-1200</b>	All except 8 cavity	Straight	Stainless steel	13	●	●	●	●
<b>1027-008-1200</b>	All except 8 cavity	Side	Zinc-plated steel	11	●	●	●	●
<b>1027-009-1200</b>	All except 8 cavity	Side	Zinc-plated steel	13	●	●	●	●



# DT Series

## Assortment Kits



- Convenient on-site service kits containing assortments of DT, DTM Series connectors, and Backshells.
- Workshop kits feature removable compartment boxes and transparent lid.
- Solid, and Stamped & Formed (F-Crimp) contact kits available.
- Connectors are environmentally sealed – IP68, IP6K9K, when installed to manufacturer's specifications.
- Contents clearly listed.

Housing :	Thermoplastic
Seal :	Silicone Rubber
Wedgeloek :	Thermoplastic
Contact :	Copper Alloy
Contact Plating :	Nickel
Shock :	50G
Vibration :	20G rms 10 – 2000Hz
Approvals :	20mm Flame Test per Standard UL-94
Ingress Protection :	IP68, IP6K9K
Operating Temperature :	-55°C to 125°C



DTKIT



DTKIT-1

## Assortment Kits – DT Series

Part No.	Kit Contents		
<b>DTKIT</b>	Receptacles & Wedgeloeks:	Plugs & Wedgeloeks:	Contacts & Cavity Plugs:
136 Piece	3 x DT04-2P & W2P 3 x DT04-3P & W3P 2 x DT04-4P & W4P 1 x DT04-6P & W6P 1 x DT04-08PA & W8P 1 x DT04-12PA & W12P	3 x DT06-2S & W2S-P012 3 x DT06-3S & W3S-P012 2 x DT06-4S & W4S 1 x DT06-6S & W6S 1 x DT06-08SA & W8S 1 x DT06-12SA & W12S	12 x Cavity Plugs (114017) 40 x F-Crimp Pin (1060-16-0122L) 40 x F-Crimp Socket (1062-16-0122L)
F-Crimp contacts Standard DT Series connectors			
<b>DTKIT-1</b>	Receptacles & Wedgeloeks:	Plugs & Wedgeloeks:	Contacts & Cavity Plugs:
136 Piece	3 x DT04-2P & W2P 3 x DT04-3P & W3P 2 x DT04-4P & W4P 1 x DT04-6P & W6P 1 x DT04-08PA & W8P 1 x DT04-12PA & W12P	3 x DT06-2S & W2S-P012 3 x DT06-3S & W3S-P012 2 x DT06-4S & W4S 1 x DT06-6S & W6S 1 x DT06-08SA & W8S 1 x DT06-12SA & W12S	12 x Cavity Plug (114017) 40 x Solid Pin – Green Band (0460-215-16141) 40 x Solid Socket – Green Band (0462-209-16141)
Solid contacts Standard DT Series connectors			



## Assortment Kits – DT Series including Tools

Part No.	Kit Contents		
<b>DTKIT-2</b>	<b>Receptacles &amp; Wedgelocks:</b>	<b>Plugs &amp; Wedgelocks:</b>	<b>Contacts &amp; Cavity Plugs:</b>
<b>138 Piece</b>	3 x DT04-2P & W2P 3 x DT04-3P & W3P 2 x DT04-4P & W4P 1 x DT04-6P & W6P 1 x DT04-08PA & W8P 1 x DT04-12PA & W12P	3 x DT06-2S & W2S-P012 3 x DT06-3S & W3S-P012 2 x DT06-4S & W4S 1 x DT06-6S & W6S 1 x DT06-08SA & W8S 1 x DT06-12SA & W12S	12 x Cavity Plug (114017) 40 x Solid Pin – Green Band (0460-215-16141) 40 x Solid Socket – Green Band (0462-209-16141)
<b>Solid contacts</b>			<b>Tools:</b>
<b>Standard DT Series connectors</b>			1 x Removal Tool (DET-RT)
<b>Crimping and Multi-use tool</b>			1 x Crimping Tool (DET16)



## Assortment Kits – DT Series 'CAT-Spec'

Part No.	Kit Contents		
<b>DTKIT-1-CAT</b>	<b>Receptacles &amp; Wedgelocks:</b>	<b>Plugs &amp; Wedgelocks:</b>	<b>Contacts &amp; Cavity Plugs:</b>
<b>136 Piece</b>	3 x DT04-2P-E005 & W2P 3 x DT04-3P-E005 & W3P 2 x DT04-4P-E005 & W4P 1 x DT04-6P-E005 & W6P 1 x DT04-08PA-E005 & W8P 1 x DT04-12PA-E005 & W12P	3 x DT06-2S-EP06 & W2S-P012 3 x DT06-3S-EP06 & W3S-P012 2 x DT06-4S-EP06 & W4S-P012 1 x DT06-6S-EP06 & W6S-P012 1 x DT06-08SA-EP08 & W8S-P012 1 x DT06-12SA-EP08 & W12S-P012	12 x Cavity Plug (114017) 40 x Solid Pin – Green Band (0460-215-16141) 40 x Solid Socket – Green Band (0462-209-16141)
<b>Solid contacts</b>			
<b>'CAT-Spec' DT Series Connectors</b>			

### 'CAT-Spec'

- Black
- Rear end cap
- Improved seal retention (plugs)

The DT Series connector housings with suffix E005, EP06 & EP08 are typically referred to as 'CAT-Spec', short for CATERPILLAR Specification.

These modified housings are used on most CATERPILLAR mining machinery as an OEM standard connector.

At a glance, they are black and feature a cap on the rear to retain the connectors' rear wire seal. The plugs include improved seal retention by using the P012 wedgelock.



DT04-3P-E005  
E005



DT06-6S-EP06  
EP06



DT06-12SA-EP08  
EP08



# DT Series



Removable compartment boxes



DTKIT-WORKSHOP



Removable compartment boxes



DTKIT-W/SHOP-CAT



## Assortment Kits – DT Series – Workshop Kits

Part No.

Kit Contents

### DTKIT-WORKSHOP

604 Piece  
Standard DT Series  
Solid contacts  
Crimping and  
Multi-use tool

Receptacles & Wedgelocks:  
10 x DT04-2P & W2P  
10 x DT04-3P & W3P  
6 x DT04-4P & W4P  
6 x DT04-6P & W6P  
3 x DT04-8PA & W8P  
3 x DT04-12PA & W12P

Plugs & Wedgelocks:  
10 x DT06-2S & W2S  
10 x DT06-3S & W3S  
6 x DT06-4S & W4S  
6 x DT06-6S & W6S  
3 x DT06-8SA & W8S  
3 x DT06-12SA & W12S

Contacts & Cavity Plugs:  
50 x Cavity Plug (114017)  
100 x Solid Pin–Green Band (0460-215-16141)  
100 x Solid Socket–Green Band (0462-209-16141)  
100 x Solid Pin (0460-202-16141)  
100 x Solid Socket (0462-201-16141)

Tools:  
1 x Crimping Tool (DET16)  
1 x Removal Tool (DET-RT)

### DTKIT-W/SHOP-CAT

604 Piece  
'CAT-Spec' DT Series  
Solid contacts  
Crimping and  
Multi-use tool

Receptacles & Wedgelocks:  
10 x DT04-2P-E005 & W2P  
10 x DT04-3P-E005 & W3P  
6 x DT04-4P-E005 & W4P  
6 x DT04-6P-E005 & W6P  
3 x DT04-08PA-E005 & W8P  
3 x DT04-12PA-E005 & W12P

Plugs & Wedgelocks:  
10 x DT06-2S-EP06 & W2S-P012  
10 x DT06-3S-EP06 & W3S-P012  
6 x DT06-4S-EP06 & W4S-P012  
6 x DT06-6S-EP06 & W6S-P012  
3 x DT06-08SA-EP08 & W8S-P012  
3 x DT06-12SA-EP08 & W12S-P012

Contacts & Cavity Plugs:  
50 x Cavity Plug (114017)  
100 x Green Band Solid Pin (0460-215-16141)  
100 x Green Band Solid Socket (0462-209-16141)  
100 x Solid Pin (0460-202-16141)  
100 x Solid Socket (0462-201-16141)

Tools:  
1 x Crimping Tool (DET16)  
1 x Removal Tool (DET-RT)



DTBS



DTBS-1



## Assortment Kits – Backshells for DT Series

Part No.

Kit Contents

### DTBS

44 Piece  
Straight style

Backshells Straight – Receptacles:  
 8 x 1011-257-0205 – Suits DT04-2P  
 5 x 1011-261-0305 – Suits DT04-3P  
 4 x 1011-265-0405 – Suits DT04-4P  
 3 x 1011-269-0605 – Suits DT04-6P  
 1 x 1011-245-0805 – Suits DT04-8P  
 1 x 1011-249-1205 – Suits DT04-12P

Backshells Straight – Plugs:  
 8 x 1011-255-0205 – Suits DT06-2S  
 5 x 1011-259-0305 – Suits DT06-3S  
 4 x 1011-263-0405 – Suits DT06-4S  
 3 x 1011-267-0605 – Suits DT06-6S  
 1 x 1011-243-0805 – Suits DT06-8S  
 1 x 1011-247-1205 – Suits DT06-12S

### DTBS-1

44 Piece  
90° style

Backshells 90° – Receptacles:  
 8 x 1011-258-0205 – Suits DT04-2P  
 6 x 1011-262-0305 – Suits DT04-3P  
 3 x 1011-266-0405 – Suits DT04-4P  
 3 x 1011-270-0605 – Suits DT04-6P  
 1 x 1011-246-0805 – Suits DT04-8P  
 1 x 1011-250-1205 – Suits DT04-12P

Backshells 90° – Plugs:  
 8 x 1011-256-0205 – Suits DT06-2S  
 6 x 1011-260-0305 – Suits DT06-3S  
 3 x 1011-264-0405 – Suits DT06-4S  
 3 x 1011-268-0605 – Suits DT06-6S  
 1 x 1011-244-0805 – Suits DT06-8S  
 1 x 1011-248-1205 – Suits DT06-12S



# DT Series



DTMKIT



DTMKIT-1

## Assortment Kits – DTM Series

Part No.

### DTMKIT

192 Piece

Standard DTM Series

F-Crimp contacts

Receptacles & Wedgelocks:  
 4 x DTM04-2P & WM-2P  
 4 x DTM04-3P & WM-3P  
 4 x DTM04-4P & WM-4P  
 2 x DTM04-6P & WM-6P  
 2 x DTM04-08PA & WM-8P  
 2 x DTM04-12PA & WM-12P

Kit Contents

Plugs & Wedgelocks:  
 4 x DTM06-2S & WM-2S  
 4 x DTM06-3S & WM-3S  
 4 x DTM06-4S & WM-4S  
 2 x DTM06-6S & WM-6S  
 2 x DTM06-08SA & WM-8S  
 2 x DTM06-12SA & WM-12S

Contacts & Cavity Plugs:  
 20 x Cavity Plug (0413-204-2005)  
 50 x F-Crimp Pin (1060-20-0122L)  
 50 x F-Crimp Socket (1062-20-0122L)

### DTMKIT-1

192 Piece

Standard DTM Series

Solid contacts

Receptacles & Wedgelocks:  
 4 x DTM04-2P & WM-2P  
 4 x DTM04-3P & WM-3P  
 4 x DTM04-4P & WM-4P  
 2 x DTM04-6P & WM-6P  
 2 x DTM04-08PA & WM-8P  
 2 x DTM04-12PA & WM-12P

Plugs & Wedgelocks:  
 4 x DTM06-2S & WM-2S  
 4 x DTM06-3S & WM-3S  
 4 x DTM06-4S & WM-4S  
 2 x DTM06-6S & WM-6S  
 2 x DTM06-08SA & WM-8S  
 2 x DTM06-12SA & WM-12S

Contacts & Cavity Plugs:  
 20 x Cavity Plug (0413-204-2005)  
 50 x Solid Pin (0460-202-20141)  
 50 x Solid Socket (0462-201-20141)



## Assortment Kits – DTM Series including Crimping Tool NEW

Part No.

### DTMKIT-2

193 Piece

Standard DTM Series

Solid contacts

Crimping Tool

Receptacles & Wedgelocks:  
 4 x DTM04-2P & WM-2P  
 4 x DTM04-3P & WM-3P  
 4 x DTM04-4P & WM-4P  
 2 x DTM04-6P & WM-6P  
 2 x DTM04-08PA & WM-8P  
 2 x DTM04-12PA & WM-12P

Kit Contents

Plugs & Wedgelocks:  
 4 x DTM06-2S & WM-2S  
 4 x DTM06-3S & WM-3S  
 4 x DTM06-4S & WM-4S  
 2 x DTM06-6S & WM-6S  
 2 x DTM06-08SA & WM-8S  
 2 x DTM06-12SA & WM-12S

Contacts & Cavity Plugs:  
 20 x Cavity Plug (0413-204-2005)  
 50 x Solid Pin (0460-202-20141)  
 50 x Solid Socket (0462-201-20141)

Tools:  
 1 x Crimping Tool (DET20)

- Environmentally sealed – IP68, when installed to manufacturer’s specifications.
- Available in 2 and 4 cavity arrangements.
- Rectangular, thermoplastic housing.
- Latched mating.
- Wedgelocks ensure contact alignment and retention.
- Accepts size 12 contacts, each with 25A continuous capacity.
- Available in kits with solid, or solid with gold-plated contact options.
- Each kit contains all components required to make both sides of a connection.



Housing :	Thermoplastic
Seal :	Silicone Rubber
Wedglock :	Thermoplastic
Contact Size :	12
Contact Rating :	25A @ 125°C
Shock :	50G
Vibration :	20G rms 10 – 2000Hz
Approvals :	20mm Flame Test per Standard UL-94
Ingress Protection :	IP68
Operating Temperature :	-55°C to 125°C



## Part Numbering System

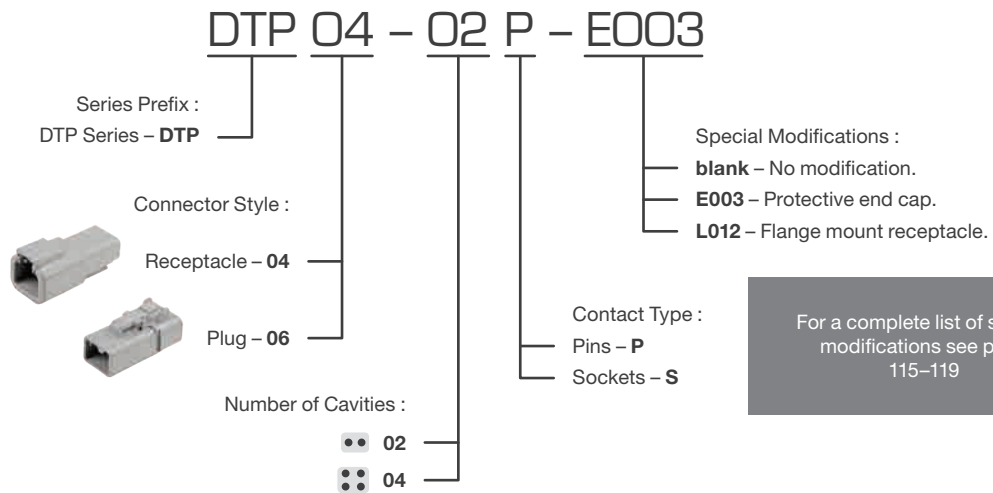

## Popular DTP Series Special Modifications

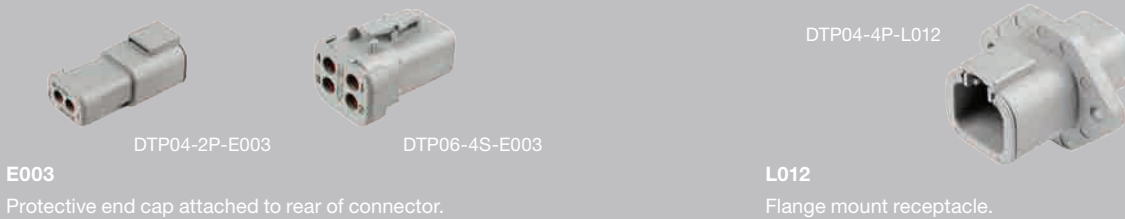

For a complete list of special modifications see page 115–119



# DT Series

DTP0X-2X

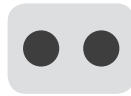

2 x size 12

DTP0X-4X

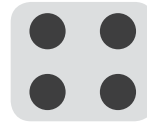

4 x size 12

## DTP Series – Popular Components

Circuits	Housing	Receptacle Components		Housing	Plug Components	
		Wedglock	Size 12 Pin – Nickel AWG14-12 / 2.0-3.0mm <sup>2</sup>		Wedglock	Size 12 Socket – Nickel AWG14-12 / 2.0-3.0mm <sup>2</sup>
2	<b>DTP04-2P</b>	<b>WP-2P</b>	<b>0460-204-12141</b>	<b>DTP06-2S</b>	<b>WP-2S</b>	<b>0462-203-12141</b>
4	<b>DTP04-4P</b>	<b>WP-4P</b>	<b>114017</b> Cavity Plug	<b>DTP06-4S</b>	<b>WP-4S</b>	<b>114017</b> Cavity Plug

For complete details on contacts & further options see page 98



DTP04-2P



DTP04-2P-E003



DTP04-4P-L012



DTP06-2S



DTP06-4S



DTP06-4S-E003

## DTP Series – Housings – Receptacles

Cavities	Part No.	Pack Quantities			
		1	10	50	Bulk Box
2	<b>DTP04-2P</b>	●	●	●	550
	<b>DTP04-2P-E003</b>	●	●	–	–
	<b>DTP04-4P</b>	●	●	●	350
4	<b>DTP04-4P-E003</b>	●	●	–	–
	<b>DTP04-4P-L012</b>	●	●	–	–

## DTP Series – Housings – Plugs

Cavities	Part No.	Pack Quantities			
		1	10	50	Bulk Box
2	<b>DTP06-2S</b>	●	●	●	1200
	<b>DTP06-2S-E003</b>	●	●	–	–
	<b>DTP06-4S</b>	●	●	●	800
4	<b>DTP06-4S-E003</b>	●	●	–	–



DTP4-1



## DTP Series – Kits

Contact Type	Size	No. of Cavities		Kit Contents: 1 x Receptacle & Wedglock 1 x Plug & Wedglock Contacts to suit
		2	4	
Solid	12	<b>DTP2-1</b>	<b>DTP4-1</b>	
Solid – Gold-plated	12	<b>DTP2-4</b>	<b>DTP4-4</b>	



WP-2P



WP-4P



WP-2S



WP-4S

## DTP Series – Wedgelocks

Cavities	Part No.	Receptacles			Cavities	Part No.	Plugs		
		1	10	50			1	10	50
2	<b>WP-2P</b>	•	•	•	2	<b>WP-2S</b>	•	•	•
4	<b>WP-4P</b>	•	•	•	4	<b>WP-4S</b>	•	•	•

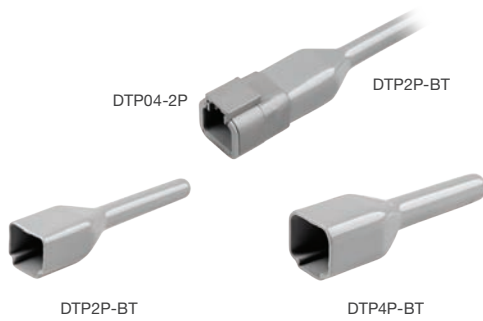

DTP2P-BT

DTP4P-BT

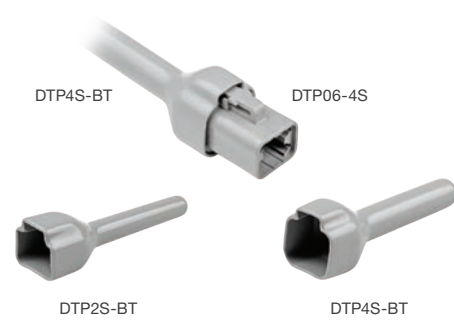

DTP2S-BT

DTP4S-BT

## DTP Series – Insulators/Boots NEW

Cavities	Suits Receptacles		Cavities	Suits Plugs	
	2	4		2	4
Part No.	<b>DTP2P-BT</b>	<b>DTP4P-BT</b>	Part No.	<b>DTP2S-BT</b>	<b>DTP4S-BT</b>
Suits	DTP04-2P	DTP04-4P	Suits	DTP06-2S	DTP06-4S

Material: Plastisol.

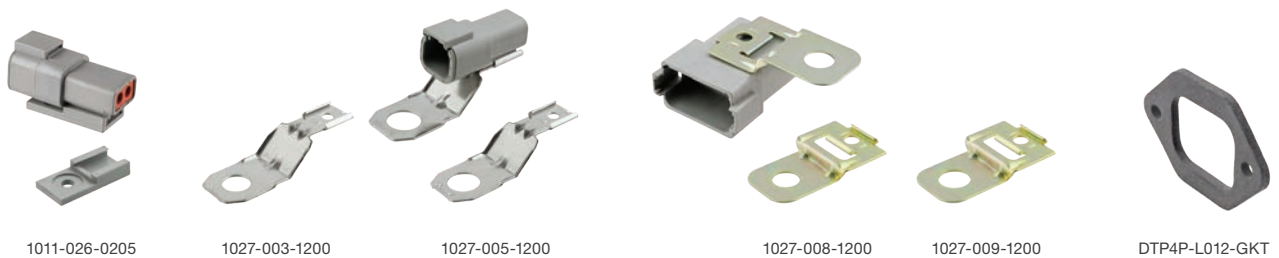

1011-026-0205

1027-003-1200

1027-005-1200

1027-008-1200

1027-009-1200

DTP4P-L012-GKT

## DTP Series – Accessories

Part No.	Description	Mounting Direction	Material	Mounting Hole Ø (mm)	Pack Quantities			
					1	10	25	100
<b>1011-026-0205</b>	Mounting Clip	Straight	Thermoplastic	5	•	—	—	—
<b>1027-003-1200</b>	Mounting Clip	Straight	Stainless steel	11	•	•	•	•
<b>1027-005-1200</b>	Mounting Clip	Straight	Stainless steel	13	•	•	•	•
<b>1027-008-1200</b>	Mounting Clip	Side	Zinc-plated steel	11	•	•	•	•
<b>1027-009-1200</b>	Mounting Clip	Side	Zinc-plated steel	13	•	•	•	•
<b>DTP4P-L012-GKT</b>	Mounting gasket suiting 4 circuit flange mount L012 receptacle (DTP04-4P-L012)							



# DT Series

DTHD Series

DTHD04-1-4P



DTHD06-1-8S

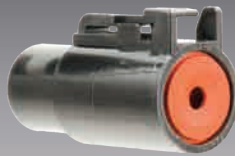

DTHD04-1-8P



DTHD06-1-12S



- Cylindrical thermoplastic design.
- Latched mating.
- Accepts contact sizes 4, 8, 12.
- 14–6 AWG.
- Single cavity arrangement.
- Each Kit contains all components required to make both sides of a connection.

Housing :  
Seal :  
Vibration :  
Operating Temperature :

Thermoplastic  
Silicone Rubber  
20G rms 10 – 2000Hz  
-55°C to 125°C

## Part Numbering System

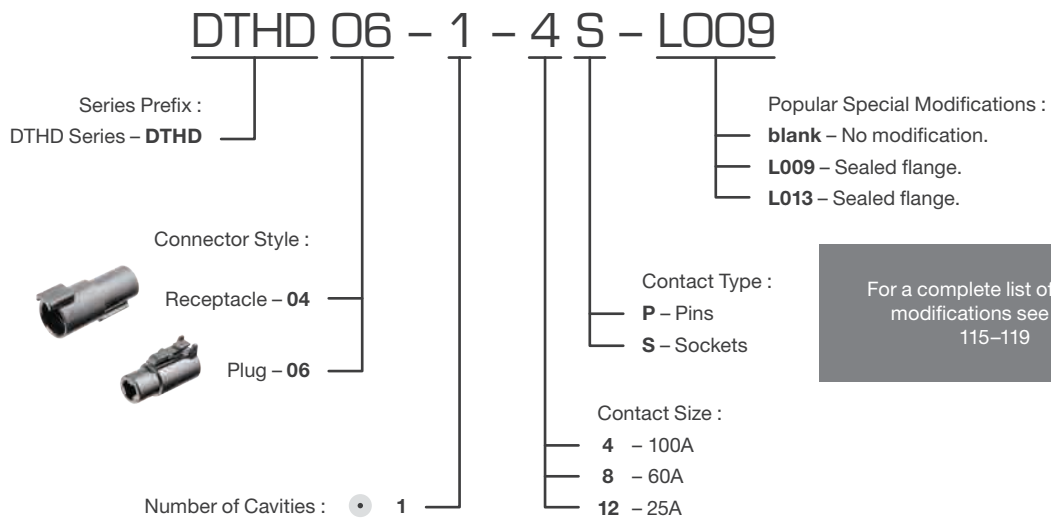

## Popular DTHD Series Special Modifications

### L009

Sealed flange. Through panel mount.  
DTHD04-1-4P only.



DTHD04-1-4P-L009

### L013

Sealed flange. Surface mount.  
DTHD04-1-4P only.



DTHD04-1-4P-L013

For a complete list of special modifications see page 115–119



DTHD04-1-4P



DTHD04-1-8P



DTHD04-1-12P



DTHD06-1-4S



DTHD06-1-8S



DTHD06-1-12S

## DTHD Series – Housings – Receptacles

Contact Size	Rating (A) @ 125°C	Part No.	Pack Quantities	
			1	10
4	100	<b>DTHD04-1-4P</b>	●	●
8	60	<b>DTHD04-1-8P</b>	●	●
12	25	<b>DTHD04-1-12P</b>	●	●

## DTHD Series – Housings – Plugs

Contact Size	Rating (A) @ 125°C	Part No.	Pack Quantities	
			1	10
4	100	<b>DTHD06-1-4S</b>	●	●
8	60	<b>DTHD06-1-8S</b>	●	●
12	25	<b>DTHD06-1-12S</b>	●	●

For complete details on contacts & further options see page 98



DTHD4-1



## DTHD Series – Kits

Contact Type	4	8	12	Kit Contents:
Solid	<b>DTHD4-1</b>	<b>DTHD8-1</b>	<b>DTHD12-1</b>	1 x Receptacle 1 x Plug Contacts to suit



1011-026-0205



1027-003-1200



1027-005-1200

## DTHD Series – Mounting Clips

Part No.	Mounting Direction	Material	Mounting Hole Ø (mm)	Pack Quantities			
				1	10	25	100
<b>1011-026-0205</b>	Straight	Thermoplastic	5	●	—	—	—
<b>1027-003-1200</b>	Straight	Stainless steel	11	●	●	●	●
<b>1027-005-1200</b>	Straight	Stainless steel	13	●	●	●	●

## Jiffy Splice JS-16-00 NEW

Also available for single contact connections is the Jiffy Splice. An ideal lightweight in-line splice for quick connections.

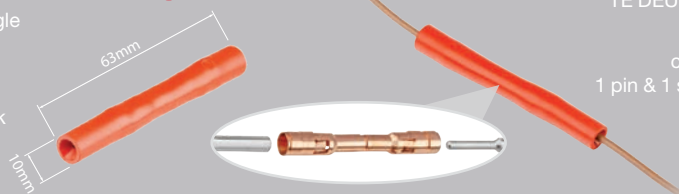

Made from the same high-quality silicone rubber as TE DEUTSCH connector seals and grommets.

The Jiffy Splice body houses a contact retention system that connects 1 pin & 1 socket (supplied by user) in a compact environmentally sealed unit.

Requires 1 x pin & 1 x socket, size 16 (16–14AWG).

