

Connectors - Environmentally Sealed

- 2 to 12 circuit configurations.
- Keyed to prevent mismatching.
- Integral retainer protects against accidental unlocking.
- Environmentally sealed.
- Chemical resistant.
- Available in assortment kits.

AMPSEAL 16



Housing : Thermoplastic
Seals : Silicone
Contact Size : 16
Contact Rating : 13A @ 125°C
Contact Material : Nickel-plated Copper Alloy
Operating Temperature : -40°C to 125°C

Plugs
(Socket Housing)

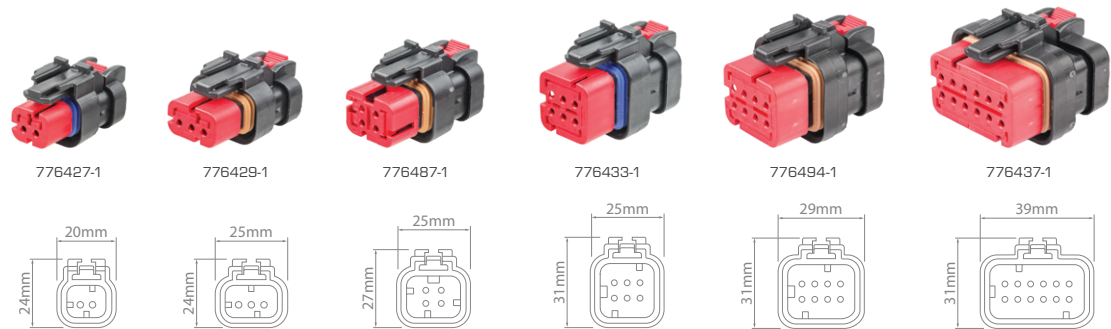

776427-1

776429-1

776487-1

776433-1

776494-1

776437-1

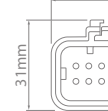
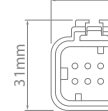
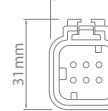
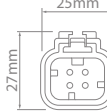
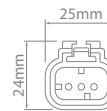
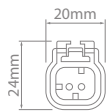
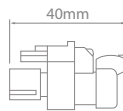

Receptacles
(Pin Housing)

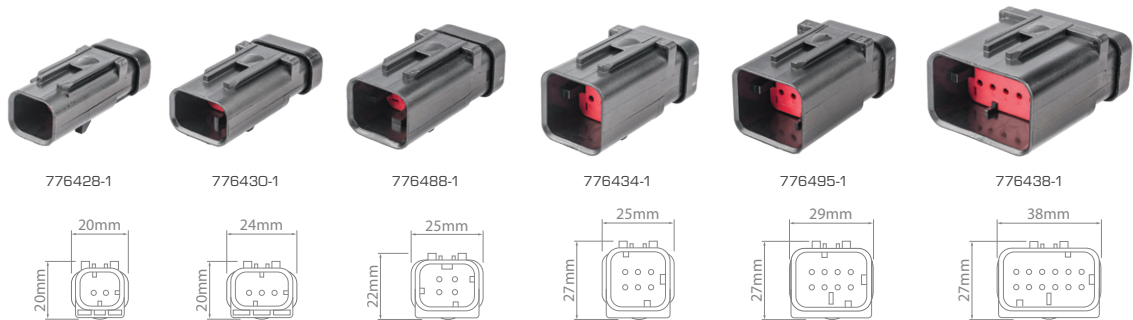

776428-1

776430-1

776488-1

776434-1

776495-1

776438-1

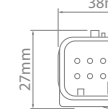
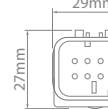
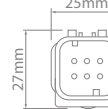
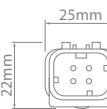
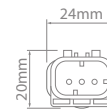
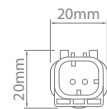
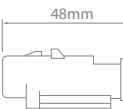

Receptacles
(Pin Housing)
Reverse Mount



1717672-1

1717673-1

1717674-1

1717675-1

AMPSEAL 16 - Connectors

	2 Circuit	3 Circuit	4 Circuit	6 Circuit	8 Circuit	12 Circuit
Plugs	776427-1	776429-1	776487-1	776433-1	776494-1	776437-1
Receptacles	776428-1	776430-1	776488-1	776434-1	776495-1	776438-1
Receptacles - Reverse Mount	1717672-1	1717673-1	1717674-1	1717675-1	—	—



Connectors - Environmentally Sealed



AMPSEAL 16 - Contacts & Sealing Plugs

Pack Qty - 20	Pack Qty - 25	Pack Qty - 100	Type (Size 16)	Suits	Wire Size (mm ²)
—	0460-215-16141/25	0460-215-16141/100	Pin, Solid - Green Band	Receptacles	1.0 - 2.0
—	0462-209-16141/25	0462-209-16141/100	Socket, Solid - Green Band	Plugs	1.0 - 2.0
—	0460-202-16141/25	0460-202-16141/100	Pin, Solid	Receptacles	0.5 - 1.0
—	0462-201-16141/25	0462-201-16141/100	Socket, Solid	Plugs	0.5 - 1.0
—	—	1060-16-0122L/100	Pin, F-Crimp	Receptacles	0.8 - 2.0
—	—	1062-16-0122L/100	Socket, F-Crimp	Plugs	0.8 - 2.0
114017/20	—	114017/100	Sealing Plug		



DET16



HDT-48-00

AMPSEAL 16 - Tools

Part No.	Description	Crimp Range (AWG)
DET16	Ratcheting. 4 indent crimper	16
HDT-48-00	Ratcheting. 4 indent crimper	12, 16, 20



AMPSEAL16-KIT



AMPSEAL16-KIT-1

AMPSEAL 16 - Assortment Kits NEW

Part No.	Description	Receptacles:	Plugs:	Kit Contents
AMPSEAL16-KIT	Solid contacts. 20 pieces AMPSEAL 16 connector.	2 x 776428-1 2 x 776430-1 2 x 776488-1 2 x 776434-1 1 x 776495-1 1 x 776438-1	2 x 776427-1 2 x 776429-1 2 x 776487-1 2 x 776433-1 1 x 776494-1 1 x 776437-1	Contacts & Sealing Plugs: 10 x 114017 Sealing Plugs 40 x 0460-215-16141 Solid Pin - Green Band 40 x 0462-209-16141 Solid Socket - Green Band
AMPSEAL16-KIT-1	Solid contacts. 20 pieces AMPSEAL 16 connector. Crimping tool.	2 x 776428-1 2 x 776430-1 2 x 776488-1 2 x 776434-1 1 x 776495-1 1 x 776438-1	2 x 776427-1 2 x 776429-1 2 x 776487-1 2 x 776433-1 1 x 776494-1 1 x 776437-1	Contacts & Sealing Plugs: 10 x 114017 Sealing Plugs 40 x 0460-215-16141 Solid Pin - Green Band 40 x 0462-209-16141 Solid Socket - Green Band 1 x DET16 4 Indent Crimp Tool